

PW1

Series 3

HIGH PERFORMANCE POTWASHER



Operator Manual



WARNING

Before installation and commissioning, you must read the safety instructions and warnings carefully and all the warning labels attached to the equipment.



IMPORTANT

Failure to comply (even partially) with the instructions given in this manual will invalidate the product warranty and relieves the manufacturer of any responsibility.



IMPORTANT

The alteration of machine operation, design or the replacement of parts not approved by the manufacturer may void warranties and approvals.

We have checked that the contents of this document correspond to the model described. There may be discrepancies nevertheless, and no guarantee can be given that they are completely identical. The information contained in this document is reviewed regularly and any necessary changes will be included in the next edition. We welcome suggestions for improvement.

Document subject to change without prior notice.

Information supplied in this manual is copyright. No part of this work may be reproduced or copied in any form or by any means, electronic or mechanical without the express permission of the author / publisher.



Distributed In
Australia by

MOFFAT®

740 Springvale Road, Mulgrave 3170, Victoria, Tel 03 9518 3888 Fax 03 9518 3818

Service 1 800 622 216
Parts 1 800 337 963

Safety Instructions



WARNING

Equipment contains dangerous voltages and can be hazardous if installed or operated incorrectly. Non-compliance with **Warnings** or failure to follow the instructions contained in this manual can result in loss of life, severe personal injury or serious damage to property.

Installation

- ◆ Use qualified, skilled personnel
- ◆ Follow installation instructions
- ◆ Connect to correct voltage and supply current
- ◆ Provide fully accessible Electrical Isolation Switch & water supply valves

Training and Supervision

- ◆ Read and Understand the Operating instructions and train all staff
- ◆ This appliance must not be operated by children or infirm persons
- ◆ Machine panels must only be removed by suitably qualified and trained personnel – internal hazards include live electrics and very hot surfaces
- ◆ This appliance is not intended for use as a stepladder

Hot Surfaces

- ◆ Some surfaces may be hot or very hot

Chemicals

- ◆ Commercial dishwashing detergents are hazardous – handle with care
- ◆ Read and follow the safety information found on the labels of detergent containers and Material Safety Data Sheets
- ◆ Use protective eyewear and clothing if decanting containers

Hot Water

- ◆ Do not put hands in wash water which may be over 60°C and contain hazardous caustic detergent
- ◆ Rinse water can be over 90°C
- ◆ Door safety switches are designed for emergency use only

Cleaning

- ◆ Do not hose down the machine or splash water over the exterior
- ◆ Watch for broken glass etc when cleaning the inside of the machine

Service/Repair

- ◆ Under no circumstances the user should attempt to carry out repairs
 - ◆ All service/repair work must be carried out by qualified personnel only
-

Installation



WARNING

Installer must be suitably qualified and ensure compliance with all codes and standards including AS/NZS3500.1.



Failure to comply even partially with installation instructions may void the warranty.

Positioning

Unpack machine, check for damage and complete delivery. Install machine on sound waterproof self-draining floor and use adjustable feet to level machine.

Allow room for detergent to one side of machine or in adjacent cupboard. 20litre container requires about 450H x 250W x 350D, but smaller containers are available from many suppliers.

Water Supply

Hot water temperature	65°C ± 5°C
Connection	20 mm (3/4" BSP Male)
Flow rate minimum	20 litres per minute
Consumption per cycle	3.5 litres approximately
Backflow prevention	Dual Check Valve fitted standard
Pressure	200-350 KPa = 30-50 Psi.

Above this range fit pressure limiter. Don't use small diameter plastic supply lines especially below this range when optional rinse booster pump may be required. FLUSH supply line before connection. Poor quality supply or excessive water hardness may affect performance or damage machine – filtration and/or softening is recommended.

Waste

40 mm gravity drain – refer to point B on the installation diagram – run waste directly behind the machine or through open side panels or base.

Power

Machine requires 3 Phase, Neutral and Earth, 400/415V, 15A/ph, 50Hz, permanently wired via wall switch mounted adjacent to machine. Wash pump rotation must be checked after installation to ensure correct direction (excessive noise and damage with incorrect direction).

Detergent

Insert pump inlet hose into container of commercial low foam detergent. Open machine door and switch machine on. Press and hold detergent prime switch behind front cover until chemical flows into machine.
Commercial detergents can be hazardous – read instructions and handle with care.

Installation Checklist

Complete attached Installation Checklist to ensure machine is installed and running correctly, and operator is familiar with operating procedures.

Troubleshooting

If the machine doesn't fill after switching on the power, check and ensure that the hot water supply tap is open, water supply pressure is not below specification and Dual Check Valve is correctly installed (arrows on the dual check valve's body specify water flow direction).

PW1W INSTALLATION DIAGRAM

PW1W INST 19-2-15 3 A

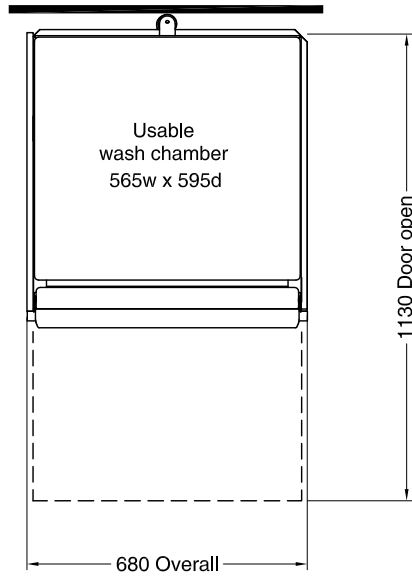

- A Hot water supply
- B Waste
- C Power supply

All Dimensions in mm

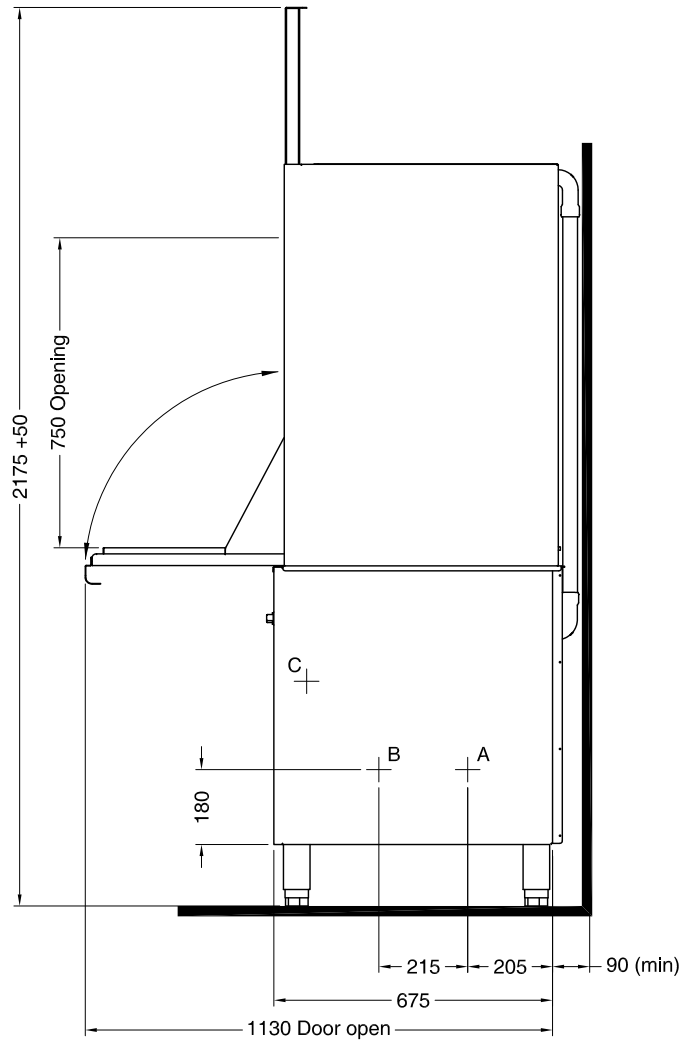
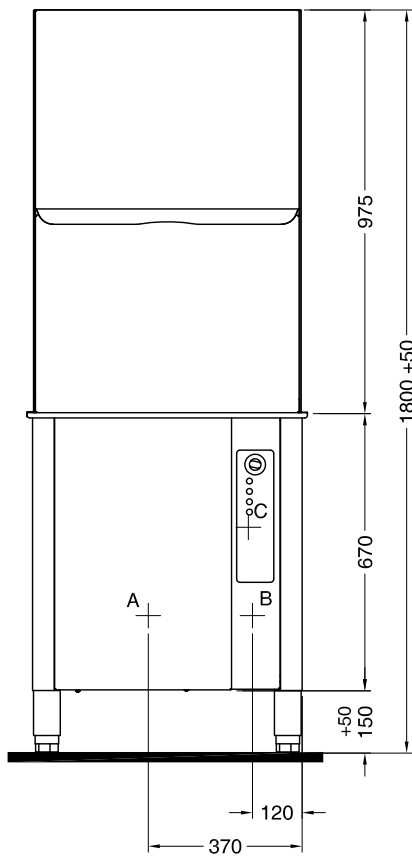

Installation Checklist

CHECK OK / NOTES

Delivery

Supplied complete no transit damage

Position

Level and stable on sound, waterproof, self draining floor

Water

Isolator valve fitted	<input type="checkbox"/>	Accessible, all fittings sound, no leaks
DCVs fitted (Washtech only)	<input type="checkbox"/>	Correct direction
Temperature	<input type="checkbox"/>	65 ± 5°C
Flow rate	<input type="checkbox"/>	Minimum 20 litres per minute
Pressure	<input type="checkbox"/>	200-350 kpa, limiter fitted if above this range
	<input type="checkbox"/>	Booster fitted if below this range
Cold water when required	<input type="checkbox"/>	Pressure not above 350 kpa
Hardness	<input type="checkbox"/>	Filter or softening if required

Power

Isolating switch	<input type="checkbox"/>	Fitted, functional and accessible
Supply as specified	<input type="checkbox"/>	Voltage, current, circuit breaker

Waste

Usually 40 mm	<input type="checkbox"/>	Sound, no leaks
Air gap on pumped drain	<input type="checkbox"/>	Very important GLV and UD models

Chemicals

	product name	container	no leaks	primed	conc.OK
Detergent	<input type="checkbox"/>	<input type="checkbox"/>	<input type="checkbox"/>	<input type="checkbox"/>	<input type="checkbox"/>
Rinse Aid	<input type="checkbox"/>	<input type="checkbox"/>	<input type="checkbox"/>	<input type="checkbox"/>	<input type="checkbox"/>

Machine operation

Run several cycles	<input type="checkbox"/>	
Confirm correct operation	<input type="checkbox"/>	Including correct fill levels

Operator training

Confirm Operator has copy of Operator Manual and is familiar with procedures

Start-up	<input type="checkbox"/>	Model / Serial	<input type="checkbox"/>
Pre-rinse and racking	<input type="checkbox"/>	Owner	<input type="checkbox"/>
Machine operation	<input type="checkbox"/>	Location	<input type="checkbox"/>
Drain	<input type="checkbox"/>	Technician	<input type="checkbox"/>
Clean	<input type="checkbox"/>	Date	<input type="checkbox"/>
Shut-down	<input type="checkbox"/>	Signed	<input type="checkbox"/>

PW1 Operating Instructions

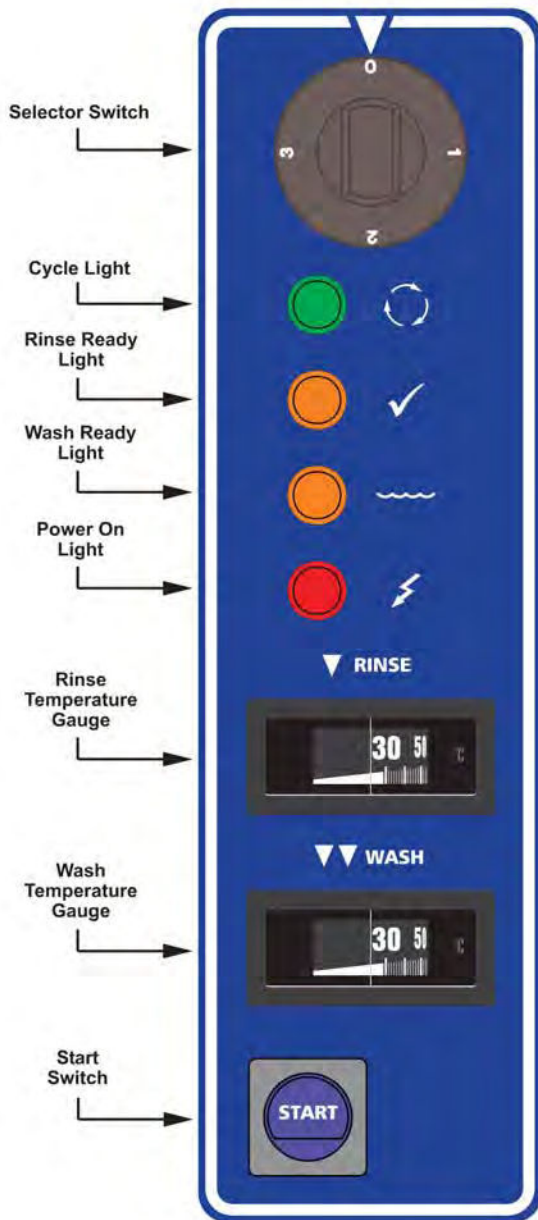

Start up

Fit drain upstand, wash pump filter, scrap trays and shut door.

Turn wall power switch on and select any cycle (1, 2 or 3).

Power light glows red and machine fills automatically.

Wash Ready light (water symbol) glows amber when wash tank is ready.

Rinse Ready light (tick symbol) glows amber when the machine is up to required temperature and ready to run.

Operation

Select required cycle (1, 2 or 3 for 2, 4 or 6 minutes cycle accordingly).

Try cycle 3 initially and switch to faster cycles only if necessary.

Load rack into machine and close door.

Press Start button to start the machine.

Cycle light glows green while machine operates.

When Cycle light goes out, cycle is complete.

Open door and remove rack.

NOTE: Machine will not operate unless Ready lights are on.

Shut down every night

Turn machine and wall power switches off.

Remove drain upstand to drain wash tank.

Remove scrap trays and wash pump filter and rinse clean.

Replace drain upstand, filter and scrap trays.

Dishwashing Procedures

for best results

Note : these are general instructions to assist in getting the best performance from Washtech dishwashers – some comments and / or illustrations may not apply to every unit.

Installation



Read the Operator Manual. Correct installation, including an adequate supply of water at the correct temperature and pressure is essential for effective operation of your machine. Refer installation instructions for details. Drain hose outlet height is important on some models. Always install on a sound self-draining floor. Water softening is recommended in hard water areas - especially for glasswashing

Pre-rinsing



Pre-scraping of dishes is required by hygiene regulations. The best method is to pre-rinse with a pre-rinse spray unit - or alternatively by scraping or dunking in water.

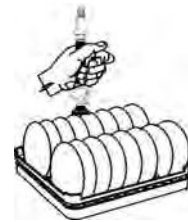

Cutlery Procedures



Pre-soak cutlery in warm water, preferably containing cutlery pre-soak compound - refer your chemical supplier.

Do not overfill cutlery containers. Cutlery should be loose with handles down. Sort after washing rather than before. Cutlery of only one type nests together and obscures wash water.

Racking Procedures

Do not overload racks, minimize the overlap of crockery. Cycle times are short and water consumption per cycle low - so there is no advantage in overloading racks.

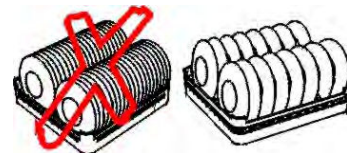

Cycle Times

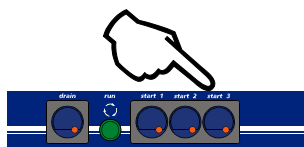

For multi-cycle machine use the longest cycle whenever possible. Note that water consumption does not increase with longer cycles. Only choose shorter, faster cycles when necessary.



Detergent

Use of correct type and quantity of low foaming commercial grade detergent is essential to the performance of the machine. We strongly recommend that you use a professional dishmachine chemical supplier - and will be pleased to recommend a supplier in your region. Discuss with them the use of cutlery pre-soak solution, detergent and drying agent.



Dishwashing Procedures

for best results

Drying



Single tank commercial dishwashers do not have a drying cycle. However, the machines do rinse at high temperatures which promote fast drying particularly when drying agents are used. We recommend prompt removal of the rack from the machine - leave the rack on the bench for 2 to 3 minutes before emptying. This time will be reduced with correct use of drying agent (rinse fluid) which reduces water surface tension and allows water to drain quickly from washware. For advice on drying agents and injectors refer to your chemical supplier.

Daily Cleaning

It is essential that the machine is drained and cleaned at the end of each day. Drain the machine then remove, clean and replace filters as per the operating instructions. Regularly check the wash and rinse jets and clean them if necessary – see below.

Regular Cleaning

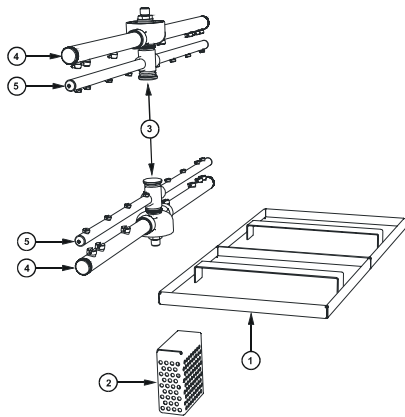

Remove scrap trays^① and wash pump inlet filter^②, where fitted, and rinse or brush clean.

Remove wash and rinse arms by undoing the central thumbscrews^③. If necessary, remove the end cap screws^④ from the wash arms and the end screws^⑤ from the rinse arms and flush the arms with water and/or use a toothpick or paperclip to clear jets.

Note: arms and filters vary with model and may appear different from this illustration e.g. those models with plastic wash arms have removable jets for ease of cleaning

Regular Servicing

Regular servicing of the dishwasher is absolutely essential to keep the machine in top working condition and obtain the best performance.

Please contact Moffat or your Authorised Service Provider to organize regular servicing of the dishwasher - discuss a Preventative Maintenance Agreement for optimum performance and long machine life.



Note : these are general instructions to assist in getting the best performance from Washtech dishwashers – some comments and / or illustrations may not apply to every unit.

Notes
