

# Gelator Showcase Freezer

## manual instruction

Read these operating instructions carefully before using the machine



---

# Index

Warning-----	1
Installation-----	2
How to Use-----	3
Maintenance-----	5
Instructions for Disposal-----	6
Technical Specifications-----	7
Working principle diagram-----	8
Trouble Shootings-----	9

---

---

## Warning:

1. This machine is a showcase.
2. This instruction manual is an integral part of the machine and must be kept for any further consultation.
3. Warning: Never try to use this machine for applications which are not described in the instructions or in a way which is not described in the instruction or under conditions which are not similar those described in the instructions, otherwise severe hazards may occur!
4. This Machine should be used only for the purpose for which it was designed .Any other use is inappropriate and therefore dangerous. The manufacturer will not be held responsible for any damage caused by improper use.
5. Before installing and operating on the Machine read carefully this operation manual.
6. Keep the machine out of reach for children ! Do not allow children to play with the machine.
7. Unplug the machine from outlet when not in use , before putting on or taking off parts, and before cleaning.
8. Be sure to unplug the machine if not using the machine in a long time.
9. If the supply cord is damaged, the cord should be replaced by the manufacturer, authorized service agent or similarly qualified persons in order to avoid a hazard.
10. Do not use the machine in a dusty environment or in an explosive atmosphere (inflammable gases, vapours and vapours from organic solvents).
11. Disable a defective machine in an obvious way, so that it does not represent a hazard to others and dispose of the machine according to the regulations from the local authorities. Please see instructions for Disposal in this manual.
12. Other than cleaning mentioned in this instruction manual, no additional maintenance or servicing of this machine is required.
13. The motor is permanently lubricated and will require no oil.
14. Repairs, when necessary, must be performed at an authorized service facility.
15. The machine is suitable for indoor use only.
16. Basic safety rules:
  - a. Do not touch the Machine when hands or feet are wet .
  - b. Do not use the Machine when barefooted.
  - c. Do not allow the Machine to be used by children or untrained persons.
  - d. Do not leave the machine outside.
  - e. Do not pull on the electrical cord when unplugging the machine.

The company reserves the right to modify the construction or appearance without notice

---

## Installation :

### Useful instruction for transport

1. In order to prevent the oil contained in the hermetic compressor from flowing into the cooling circuit, it is necessary to always carry store and handle the machine in a vertical position, following the instructions found on the packaging.
2. If the machine was accidentally or purposely placed in a non-vertical position during transport, before operating the machine, it should be kept in a straight position for approximately 30mins to allow the oil to flow back into the compressor.

### Unpacking:

machine has not been damaged Remove the plastic film from all the stainless steel panels (if has)

**Important:** The various packaging should be kept from Children since they are potentially dangerous. Dispose the packaging according to the regulations from the local authorities.

### Positioning:

1. Do not install the machine in the area where water jet could be used.
2. Place machine on a horizontal and sturdy surface
3. Please install the machine in locations where can be overseen by trained personnel
4. For good ventilation, keep a distance of 20cm(7 inches), between unit and wall or other objects increase the distance if the obstacles are a heating source When the dispenser is in place ,press the brake on the wheels in order to keep it level.(FIG.I)

### Assembling

- 1 Remove the bottom pallet from the machine
- 2 Put shelves board on to the shelves

### Electrical connection

Before inserting the plug in to the electrical socket, carefully read the following precautions:

1. Make sure that the machines properly connected to an efficient grounding system, in compliance with current safety standards
2. Make sure that the voltage is in accordance with what indicated on the "serial number C label applied on the chassis
3. The current available is sufficient for the maximum required by the machine
4. if necessary, use only approved multiple outlets, in compliance with current safety Standards.

If in doubt, consult only specialized technicians Bylaw, the machine must always be grounded By Law....,the machine must always be grounded.

---

## How To Use:

Before using, the machine should be cleaned carefully as it comes in contact with food  
Functioning

1. Make sure that the main switch is in the [ I ] position , plug in the machine
- 2 Before starting the machine, ensure the sliding doors are properly closed
- 3 Turn the main switch to [ I ] position, the condensing unit will automatically start
- 4 For lighting, press lighting button. The lighting button locates on the thermostat
- 5 if there is some condensations on front curved glasses, please turn the switch to [ I ] position for defogging
- 6 Cut off the power, and then you can change the light follow the below steps.
  - a. Remove the transparent light lid.
  - b. Hold both sides of the light with hands whirl it unit you can remove it from the light seat.
  - c. Install the new light tube in the reverse order.
  - d. Cover the light lid.

The company.. reserves the right to modify the construction or appearance without notice.

## Working Temperature Adjustment

To reset the temperature inside the showcase, please follow as below:

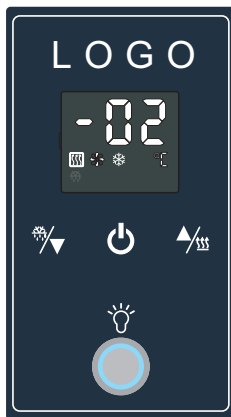

Display



Button for defrost/  
decrease set temp.













Button for demist/  
increase set temp.













Turn on/Turn off Button



Light Button

- 1.Plug in the machine.
- 2.Before starting the machine, ensure the sliding doors are properly closed.
- 3.For lighting, press the light button below the thermostat.
- 4.Press  for 3s to startup.
- 5.Press  for 3s to shut down.
- 6.Set temperature: press  for 1s, the setting temperature flashing, and then press   to alter the setting temperature. It will display the working temperature after stopping setting for 6s.
- 7.Manual demisting, press  for 3s, then  shows on the display and the manual defrosting starts. Long press  for 3s again to stop.
- 8.Manual defrosting, press  for 3s and  shows on the display and the manual defrosting starts. Long press  for 3s again to stop.
- 9.To reset the parameters inside the showcase, please follow as below;

**CAUTION:** You are suggested not to reset the temperature controller frequently.

- a. Press  for 1s to set temperature, then press  again, it will show "PAS".
- b. Press   to enter password (The default password is 15).
- c. Press  for 1s, you can see parameter code "E1", and you can press  to show "E2" to "C2".
- d. To adjust the value please press  for 1s again, then press   to change the value.
- e. Press  again to confirm and recover parameter code selection.
- f. Without press any button for 6s, it will recover working temperature display.

Notes: If the password is incorrect, you can only check parameter but could not change it.

The factory default value of set temp. is -18°C.

parameter	function	range	default
PAS	Password	0~100	15
E1	Lower setpoint limit	-45°C~SET	-25°C
E2	Higher setpoint limit	set temp. ~45°C	0°C
E3	Temp. hysteresis	1~10°C	4°C
E4	Compressor start delay time	3~8min	3min
E5	Temperature probe adjustment	-5~5°C	0°C
E6	Defrosting probe adjusting	-2~+2°C	0°C
F1	Max. defrost duration	1~60min	60min
F2	Defrosting interval time	0~24hr	4hr
F3	Defrost termination temperature	8~25°C	15°C
F4	Display during defrost	0= normal display 1= last value before defrost	1

parameter	function	range	default
F5	Fan motor running type	=1 Running all the time =0 Running with the compressor[Except defrosting]	1
F6	Drip time	0~10min	2min
F7	Fan motor running type after defrosting	=0 Running after delay =1 Running according to the temp.	0
F8	Fan motor running type after defrosting	0~10min	2
F9	Fan motor running temp. after defrosting	-20~+20°C	-8°C
C1	Compressor stop time when Failure mode	5~10min	5min
C2	Compressor working time when Failure mode uptime	5~10min	10min

---

## Function Description

### 1.temperature control

When the working temp. is higher than set temp. and temp. hysteresis E3, the compressor starts. When the working temp. is lower or equal to set temp., the compressor stops. In order to protect compressor, it can only start after Compressor start delay time E4.

### 2.Defrosting function

After working for defrosting interval time (parameter F2), it will start defrosting automatically, the defrost LED lights is on and compressor stops. Time of defrosting reaching parameter F1, it will stop defrosting and enter normal temperature controlling mode.

When defrost interval time (parameter F2) is set "00", it will cancel automatic defrosting.

### 3. Display last value before defrost when defrosting

- a. When parameter F4=0, it displays working temperature during defrosting.
- b. When parameter F4=1, it displays last value of working temp. during defrosting. After defrosting, it recovers normal display after 20 minutes, or when working temp. lower than set temp.. Defrost LED light flashes during the time of delay.

### 4. Sensor of Cabinet Temp. Failure working mode

It displays "Sc" when sensor of cabinet temp. short circuits or working temp. higher than 99°C . While it will display "So" when sensor of cabinet temp. open circuits or working temp. lower than -45°C;When the temperature failure, the machine working as below: the compressor working for C2 set time, and then stops ,after C1 set time, it will start again.

## Maintance:

Ovsrve the ambient temperature

The machine is suitable for an ambient temperature ranging between 16 °C - 32 °C

### Cleaning

For health standard and good quality of beverages or foods, clean interiors of machine as often as possible

---

**Caution:**

Do not clean the machine by water jet

1. Before carrying out cleaning, remove the power plug
2. Do not use abrasive powders that might impair the interior parts of showcase
3. Use neutral soap and a little warm water to wash the interiors, Rinse carefully with water in order to remove any residual of soap
4. To maintain a high standard of working performance, leave the machine turned on night and day in order to avoid deposit

**Caution:**

Do not use any organic solvents (petrol, alcohol, etc ) for cleaning the machine The case of the machine may be damaged and explosive vapours may develop Do not use any sharp edged objects for cleaning

The machine may be cleaned with a damp towel, but may never get in direct contact with water After cleaning the machine make sure that it will be dried completely

## Instructions for Disposal

When replacing your old machine with a new one, please comply with the following information:

Old machines are not worthless rubbish Valuable raw materials can be reclaimed by recycling old machines

**Render old machine unusable:**

- 1 Pull out the mains plug,
- 2 Cut off the mains cable and discard with the mains plug,

**Caution:**

Refrigerants in refrigeration machines and gases in thermal insulation must be disposed of Professionally. Ensure that refrigeration tubing is not damaged prior to disposal. Please discard the machine according to the regulations from the local authorities.



---

## Technical Specifications

MODELS	IEC100D64	IEC120D64	IEC150D64
Parameter	220~,50HZ		
Capacity (L)	235L	265L	300L
Power (W)	652	824	940
Working Temp. (°C)	-18~-22°C		
Gas	R404a		
Weight (Kg)	146	221	300
Climate Class	N		
Classification of protection against electric	I		
LED (w)	20	30	40
Dimensions (cm)	100X64X115	120X64X115	150X64X115

### Noted

- 1.When the voltage and Hz are different , the performance function will not be affected. But the technical specifications will be different a little bit..
- 2.The weighted sound pressures of the machines are below 70db.

## Working principle diagram

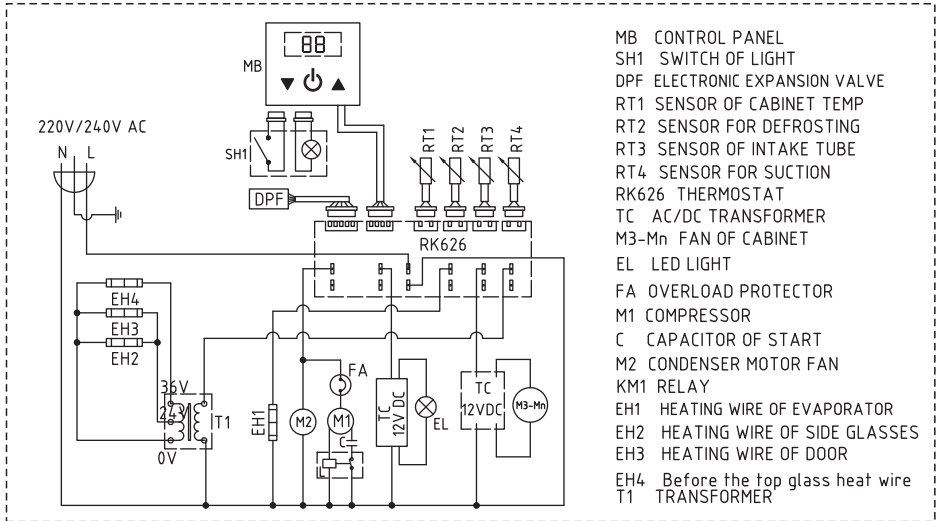

## Trouble Shooting:

Symptom	Possible reasons	Solution	Remark
•No power input/power direction lamp is not light	<ul style="list-style-type: none"> <li>• Broken fuse</li> <li>• Poor contact of plug and socket</li> <li>• Failure in input control circuit</li> </ul>	<ul style="list-style-type: none"> <li>• Replace</li> <li>• Repair or replace the socket</li> </ul>	Ask for authorized service department to check and repair
• Compressor does not work	<ul style="list-style-type: none"> <li>• Thermostat does not work</li> <li>• Thermostat is not on the working position</li> <li>• Poor contract of the thermostat</li> <li>• Lose plug pins of the starter</li> <li>• Broken compressor</li> <li>• Broken starter r capacitor</li> </ul>	<ul style="list-style-type: none"> <li>• Replace</li> <li>• Turning to the working position</li> <li>• Insert the plug tightiy</li> <li>• Replace</li> <li>• Repair or replace</li> </ul>	
• Compressor run the temperature in the showcase is high	<ul style="list-style-type: none"> <li>• Ambient temperature is too high.</li> <li>• Too much dust and dirt on the condenser</li> <li>• Frost on the evaporator is too thick</li> <li>• Thermostat out of work</li> </ul>	<ul style="list-style-type: none"> <li>• Adjust the thermostal properly</li> <li>• Clean it on time</li> <li>• Stop the machine to defrost. Set the temperature properly higher</li> <li>• Replace</li> </ul>	Ask for authorized service department to check and repair it.
• Condenser fan does not run	<ul style="list-style-type: none"> <li>• The capacitor of the fan out of work</li> <li>• The ball-bearing of the fan motor is lack of oil</li> <li>• The winding of the fan motor damaged</li> </ul>	<ul style="list-style-type: none"> <li>• Replace Fill oil Replace</li> </ul>	
• Compressor Starts/stops frequently	<ul style="list-style-type: none"> <li>• The winding of the compressor is short circuit</li> </ul>	<ul style="list-style-type: none"> <li>• Check with a multi-meter,replace the compressor</li> </ul>	
• The fan of the evaporator does not work	<ul style="list-style-type: none"> <li>• Poor contact f the socket</li> <li>• The fan motor damaged</li> </ul>	<ul style="list-style-type: none"> <li>• Repair or replace</li> <li>• Replace</li> </ul>	

**Warning:** If the machine has any problem or has been damaged, do not try to repair or replace it by yourself. Please ask for the authorized service department for help.

---

A series of 25 horizontal dashed lines for writing.

