

# Use and maintenance manual

*Lo Stagionatore*



# MEAT MEAT PANORAMA

EVERLASTING

**Thank you for choosing this product.**

Please read the warnings contained in this manual carefully, as they provide important information regarding safe operation and maintenance.

Make sure to keep this manual for any future reference by the various operators.

In some parts of the manual, the  symbol appears, indicating an important warning that must be observed for safety purposes.

## CHAPTER 1 BOUNDARY CHARACTERISTICS OF OPERATION

The refrigerated cabinet has been designed and built to operate in optimal conditions at temperatures from +10°C to +40°C, with adequate air circulation. In places with characteristics that are different from the requirements, the stated performance cannot be guaranteed.

The supply voltage must be 230V +/- 10% 50Hz as standard, or as indicated on the EC label.

The refrigerated cabinet may only be used within the temperature limits specified by the manufacturer; to identify the correct operating range, read the letters after the last digit of the model shown on the EC label and compare it with the table below:

Serie	Temperature
<b>MEAT</b>	-2° +10°C / 40÷90% U.R.
<b>MEAT PANORAMA</b>	0° +10°C / 40÷90% U.R.

The refrigerated cabinet complies with the European directives as described in detail in the Annex **“EC Declaration of Conformity”**

The technical specifications of the refrigerated cabinet are listed on the CE label inside the motor compartment, on the body wall

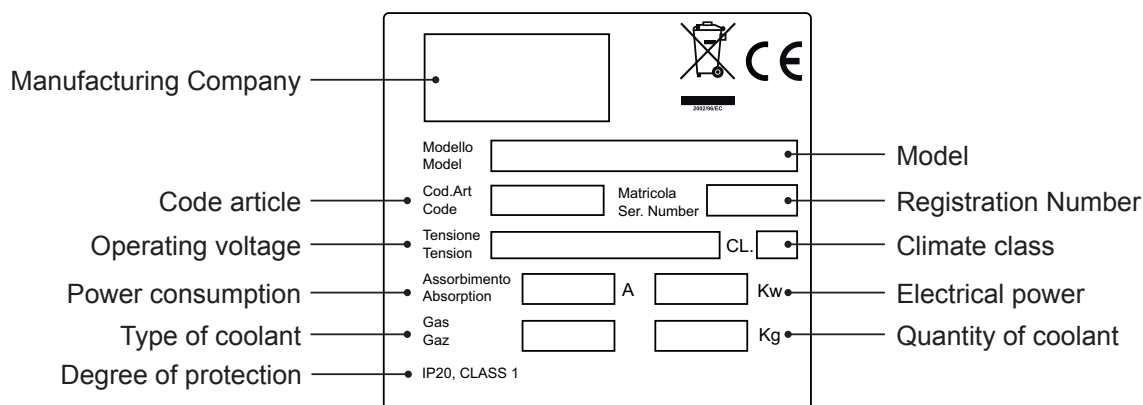

 **ATTENTION:** any request for intervention, technical support and spare part must refer to the **SERIAL NUMBER** on the CE label, on the manual cover or on the compressor motor. The producer declines any responsibility for any improper or not reasonably foreseen usage of the refrigerated cabinet and for any operation carried out by neglecting the indications listed on the manual.

## Section 1: GENERAL INSTRUCTIONS

### 1.1 TESTING AND GUARANTEE

The appliance is tested in our works in compliance with established regulations and then shipped ready for use.

The guarantee is valid for a full 12 months from the date of delivery of the appliance and it covers the repair or replacement of any defective parts, with the exception of electrical and electronic components.

Manifest defects or differences with respect to the client's order must be communicated to the manufacturer within five days from the receipt of the goods or they will not be covered by the guarantee terms.

Any hidden or other defects must be communicated to the manufacturer within five days from the time that they are discovered and, in any event, within the maximum guarantee term of 12 months. The purchaser shall be entitled only to request repair or replacement of the goods. The purchaser is not entitled to claim compensation for direct or indirect damages of any whatsoever nature. In any case, the right of reparation or replacement of materials will have to be exercised within the warranty maximum time limit of 12 months from delivery date.

Repairs or replacement of defective materials will be carried out at the manufacturer's works; material returned to the manufacturer must be shipped carriage paid and will be returned to the purchaser carriage forward.

### 1.2 INTRODUCTION

This manual has been prepared with the scope of supplying all the instructions required for the correct use of the appliance and to maintain it in optimal condition. It also contains important user safety information.

The following professional roles are explained in order to define the responsibilities of each:

**Installer:** a qualified technician who positions the appliance and places it in service in accordance with the instructions in this manual.

**User:** the person who, after reading this manual carefully, operates the appliance in accordance with the intended use specified in this manual.

Users' responsibilities:

- to ensure that food products are conserved at suitable temperatures and not exceeding the permitted period of time
- to be aware of the regulations governing the conservation of food and to observe any whatsoever hygiene indications that may be applicable.

The user is obliged to read the manual attentively and refer to the information in the manual at all times.

Particular attention must be paid to the contents of heading 1.5 **General Safety Warnings**.

**Routine Maintenance Technician:** qualified technician able to perform routine maintenance of the appliance by following the instructions in this manual (see section 5).

**Special Maintenance Technician:** qualified technician, authorized by the manufacturer to perform extraordinary maintenance of the appliance (see section 6).

The symbol  appears at certain points in the manual to draw the reader's attention to important safety information.

The manufacturer declines any whatsoever responsibility in the case of improper use of the appliance deviating from the reasonably construed intended use, and for all operations carried out that are not in compliance with the instructions laid down in the manual.

This manual must be conserved in a place that is accessible and known to all operators (installer, user, routine maintenance technician, special maintenance technician).

This manual must not be reproduced or divulged, in whole or in part, using any whatsoever means or in any whatsoever form.

### 1.3 PRODUCT DESCRIPTION

The appliance comprises a modular single body with panelling in various materials and insulation in expanded polyurethane foam, density 42 kg/cu.m. The appliance instruments are located on the front panel which closes the front of the motor unit, inside which the condenser unit and electrical wiring can be housed. The refrigerator interior is fitted with suitable supports for wire shelves (grids) and/or other accessories. The doors are fitted with an automatic return device and magnetic seal elements. During the design and construction stage all measures have been adopted to implement total safety including radiused interior corners, funnel-shaped base panel to convey condensate to exterior, no rough surfaces, fixed guards protecting moving or potentially dangerous parts.

### 1.4 GENERAL SAFETY REGULATIONS

Read this manual carefully and follow the prescriptions contained herein.

The user assumes full responsibility in the case of operations carried out without observing the instructions in the manual.

Primary general safety regulations:

- do not touch the unit with wet hands and/or feet
- do not use the appliance with bare feet
- do not insert screwdrivers or other pointed objects between guards or moving parts of the appliance
- do not pull the power cord to disconnect the appliance from the electrical mains
- make sure that the appliance is not used by children or unsuitably qualified persons
- before performing any cleaning or maintenance on the appliance disconnect it from the electrical mains by switching of the main switch and extracting the plug
- in the case of faults or malfunctions, switch off the appliance and do not attempt to repair it yourself. All service and repair operations must be performed exclusively by suitably qualified authorized technicians.

### 1.5 CLIENT'S RESPONSIBILITIES

The customer is required to:

- execute the electrical and hydraulic connection of the appliance
- prepare the place of installation
- provide consumable materials for cleaning
- perform routine maintenance
- Provide adequate protection for pipes and cables external to the appliance.

In the case of power failures or malfunctions do not open the doors and drawers in order to maintain uniform temperature inside the unit. If the problem persists for more than a few hours, move the food contents to a more suitable place.

## 1.6 CLIENT SERVICE REQUESTS

For all technical problems and any requests for technical service, refer exclusively to your local dealer.

## 1.7 ORDERING SPARE PARTS

Spare parts orders must be made by consulting the relative spare parts catalogue which gives the correct description of the part, the part reference code and the serial number of your appliance. Consult your dealer.

## Section 2: SPECIFICATIONS

### 2.1 PRODUCT CONFIGURATION

The appliance is designed solely for the preservation of food products (see heading 4.1). The products must be stored in observance of the load limits shown in the table and in figure 1 in order to ensure efficient air circulation inside the appliance (fig.1).

	Type	Load limits mm		
	Model	L	H	P
	700-1500	530	1500	650

fig.1

Model	Kg
700	150
1500	300

### 2.2 NOISE LEVEL

The noise level of the appliance is below 70 dB (A).

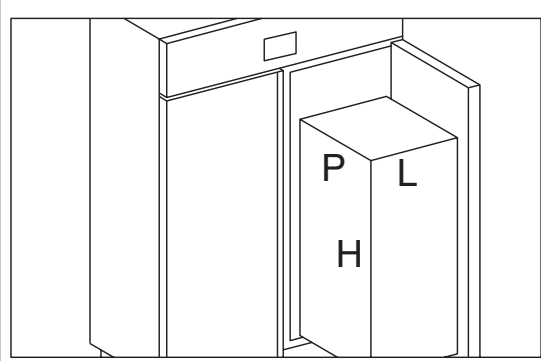
### 2.3 MATERIALS AND REFRIGERANTS

The materials in contact or which may come into contact with foodstuffs comply with the relevant directives. The refrigerated cabinet has been designed and built in such a way that these materials can be cleaned before each use. R452A is a fluorinated gas covered by the Kyoto Protocol with a GWP potential of 2141



The symbol indicates that this product must not be treated as household waste.

To prevent potential negative consequences for the environment and human health, make sure that this product is properly disposed of and recycled. For more information regarding the disposal and recycling of this product, please contact your Distributor, after sale Service, or waste treatment Service.

## Section 3: INSTALLATION

### 3.1 TRANSPORT AND HANDLING

**⚠** *The appliance must be transported and handled exclusively in a vertical position, in observance of the instructions printed on the packing.*

This precaution is necessary to avoid contamination of the refrigerant circuit with compressor lube oil with resulting valve and heat exchanger coil failure and problems starting the electric motor.

The manufacturer accepts no responsibility for problems due to transport executed in conditions other than those specified above.

The accessories supplied with the appliance (runners, wire shelves, basins, trays) are supplied in separate packs shipped inside or separately from the unit.

The appliance is secured to a wooden base by means of plastic ties (fig.2) and wrapped in polyethylene or packed in a carton, cage or crate.

Refer to heading 3.6 for information on correct disposal of packing material.

**⚠** *The appliance must be handled using a fork lift truck or a pallet truck with suitable forks (fork length at least equal to 2/3 length of unit).*

Maximum permissible stacking and the position of the centre of gravity are shown on the information label on the packing.

### 3.2 POSITIONING

Incorrect positioning can cause damage to the appliance and generate hazardous conditions for personnel. The installer must therefore observe the following general regulations:

- make sure you maintain a minimum of 3 cm from the walls
- the room must be well ventilated
- keep well away from sources of heat
- avoid direct sunlight

Specific positioning procedures

- remove packing material (polyethylene, cardboard box, crate, cage)

**⚠** *Polyethylene is potentially dangerous to children*

- remove accessories from inside the unit.

Removing the wooden base: tilt the unit sideways and cut the plastic ties (fig.2) lift and remove the base.

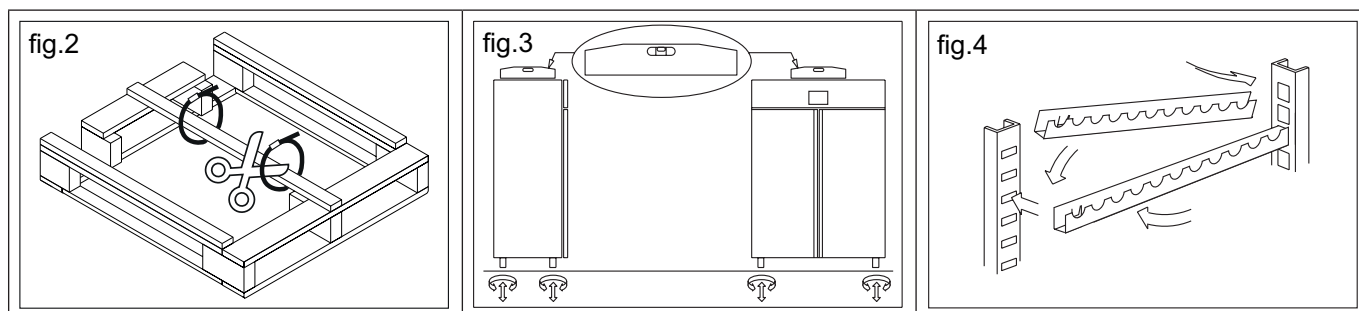

**⚠** *use gloves when handling wooden packing materials and the wooden base to protect the hands from splinters*

- position the appliance with the help of a spirit level. Adjust the leveling feet on the metal base of the unit if necessary (fig.3)
- remove the protective PVC film from the external surfaces of the unit
- position the shelf runners in the holes in the uprights (fig.4)
- insert the food shelves in the runners
- insert the condensate collection tray in the relevant runners located beneath the unit

### 3.3 WIRING AND ELECTRIC / WATER CONNECTION

The electrical plant and electrical hook-up operations must be performed by a qualified electrician

For safety reasons adhere to the following indications:

- check that the electrical plant is suitably sized for the absorbed power of the unit
- if the electrical socket and the plug on the appliance power cord are incompatible, change the plug with a suitable component, ensuring the replacement part is of the approved type
- do not use reductions or multi-way adapters (fig.5)

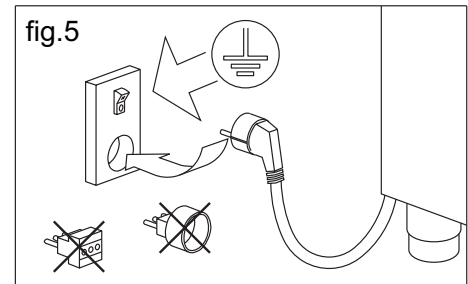

**⚠** *It is important to connect the appliance correctly to an efficient earth system executed in compliance with the relevant legislation.*

### 3.4 SET-UP OPERATIONS

**⚠** *To avoid errors and accidents, perform a series of checks for possible damage sustained during transport, installation and hook-up operations before starting up the unit.*

#### Preliminary Checks

- check the condition of the power cord (no cuts or chaffing)
- check that the feet, door hinges and shelf supports are stable
- check the condition of internal and external components (pipelines, heat exchanger elements, fans, electrical components, etc.); check also that all parts are firmly fixed into position
- check that the door seals and drawers are not damaged (broken or scratched) and that the doors close and are sealed properly

The user must also observe the following instructions to obtain the best operation from the appliance:

**⚠** *Indications for Optimal Duty*

- do not block the motor compartment air vents
- make sure doors are kept closed
- keep the defrost water drain outlet clear
- limit the frequency and duration of opening; each time the door is opened the internal temperature will alter
- perform routine maintenance regularly (see section 5).

### 3.5 RE-INSTALLATION

Observe the following procedure:

- switch off the appliance from the main switch
- disconnect the power cord from the electrical outlet
  
- handle the appliance in accordance with the instructions in heading 3.1
- follow the instructions in headings 3.2 and 3.3 for positioning and hook-ups in the new location

### 3.6 SCRAPPING AND DISPOSAL

Scrapping and disposal of the appliance must be carried out in full observance of established legislation in your country.

## Section 4: OPERATION

### 4.1 APPLICATIONS AND INTENDED USE

#### 4.1.1 Intended Use and Permitted Use

The appliance is designed and built for refrigerating, preserving and storing food products on commercial premises.

#### 4.1.2 Improper and Unauthorized Use

1) treatment of products that require constant monitoring with indications in the case of temperature changes or interruption of refrigeration. For example:

- medicinal products
- blood and plasma
- thermo-sensitive chemical reactants

2) use in places subject to explosive atmosphere

All uses except authorized uses of the appliance shall be construed as “improper use” for which the manufacturer declines all responsibility.

### 4.2 SAFETY AND ACCIDENT PREVENTION

The appliance embodies various features designed to assure the safety and protect the health of the user. The following list describes the protections adopted against mechanical risks:

- **stability:** the appliance is designed and built so that even with the shelves fully extracted in the intended conditions of operation it will remain stable so that it can be used with no risk of tipping, falling or sudden movement

- **surfaces, edges, corners:** accessible parts of the appliance have no sharp corners, sharp edges or rough surfaces that could cause injury

- **moving parts:** moving parts of the unit are designed, built and configured to avoid risk. Moving parts are protected by fixed guards to prevent accidental contact that could result in injury  
Measures adopted for protection against additional risks:

- **electrical power:** the appliance is designed, built and fitted out with the aim of preventing the risk of electric shock in compliance with established safety legislation



- **noise**: the appliance is designed and built to reduce risks related to the emission of airborne noise to a minimum

### 4.3 SAFETY DATAPLATES AND GUARDS

It is strictly forbidden (fig.6):

- to tamper with or remove the evaporator cover that protects the user from the risk of cutting on the heat exchanger fins
- to remove the dataplate fixed to the inside edge of the motor housing showing technical specifications (1) and earth connection warning (2)
- to remove the dataplates on the evaporator unit cover near the electrical wiring inside the motor housing which warn the user to disconnect electrical power before working on appliance (3)
- to remove the dataplate fixed inside the motor compartment indicating earthing (4)
- to remove the data tag fixed to the power cord showing the type of power supply (5)

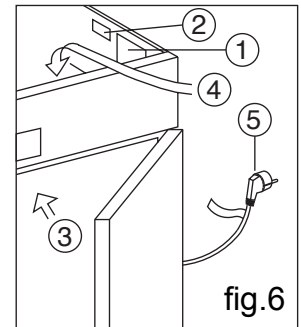

The manufacturer declines all responsibility for safety of the appliance if the above recommendations are not observed.

### 4.4 OPERATING LIMITS

The appliance is designed and built to work in ambient temperatures Max. 38°C. If the ambient conditions are different it will not be possible to achieve the performance levels specified by the manufacturer.

The standard power supply must be 230V +/- 10% 50Hz.

## Section 5: ROUTINE AND PROGRAMMED MAINTENANCE

The information in this section regards the user, or other non-specialized personnel, and the routine maintenance technician.

### 5.1 BASIC SAFETY REGULATIONS

We summarize the safety regulations already shown in heading 1.5 to ensure that the user or maintenance technician can perform the work in conditions of total safety:

- do not touch the unit with wet hands and/or feet
- do not use the appliance with bare feet
- do not insert screwdrivers or other pointed objects between guards or moving parts of the appliance
- do not pull the power cord to disconnect the appliance from the electrical mains
- before performing any cleaning or maintenance on the appliance disconnect it from the electrical mains by switching of the main switch and extracting the plug

#### 5.1.1 Prohibited: Removal of Guards and Safety Devices

It is strictly forbidden to remove guards or safety devices when performing routine maintenance work. The manufacturer disclaims all liability that may arise if this regulation is not observed.

#### 5.1.2 Indications on Emergency Measures in Case of Fire

- disconnect the appliance from the electrical power socket or switch off the master switch on the electrical mains line
- do not use water to douse fires
- use Co2 extinguishers

## 5.2 CLEANING THE REFRIGERATOR

The unit is designed to preserve food products so it is important to keep it clean for reasons of hygiene and health. The appliance is thoroughly cleaned in our factory before delivery. We recommend, however, that you clean the interior of the appliance before use. Before cleaning the appliance make sure the power cord is disconnected.

### 5.2.1 Cleaning the Interior and Exterior of the Appliance

- cleaning products: water and non-abrasive neutral detergent. **DO NOT USE SOLVENT OR THINNERS**
- cleaning method: use a cloth or sponge soaked in a suitable cleaning product to clean the interior and exterior parts of the cabinet
- sanitation: do not use substances that could alter the taste and smell of stored food
- rinsing: use a cloth or sponge soaked in clean water. **DO NOT USE WATER JETS**
- frequency: once a week or at different intervals in accordance with the type of food product conserved.

### 5.2.2 Cleaning the Condenser

The condenser will work less efficiently if it is obstructed with foreign material so it must be cleaned once a month. Before cleaning the condenser switch off the appliance, disconnect the power cord and proceed as follows:

**Top-mounted unit.** -for units with fixed upper front panel, use a safe step ladder for direct access to the condenser located at the top of the appliance. Use an air jet or a dry brush and,

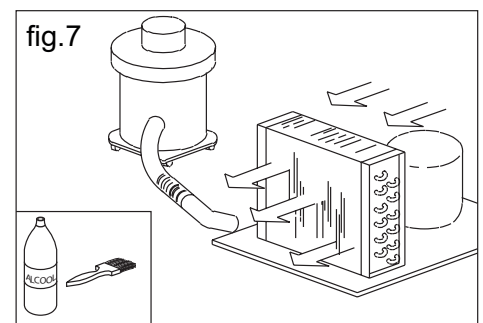

working with up and down movements (fig.7), remove any dust or fluff that has deposited on the heat exchanger fins. In case of greasy deposits, use a brush soaked in benzene or alcohol. For units with overturning upper front panel, unscrew the fixing screw and turn the upper panel on the top hinges. Proceed then with the cleaning as for the models with fixed upper panel. Start the appliance after cleaning.

**⚠** *During this operation use the following personal safety measures: safety glasses, respirator mask, chemical resistant gloves (benzine - alcohol).*

## 5.3 PERIODIC CHECKS

The following areas of the appliance or component assemblies require periodic checking:

- condition and efficiency of the door sealing elements
- condition of hinges and correct fixing of the doors
- condition of electrical cables and electrical parts

## 5.4 PRECAUTIONARY MEASURES FOR PROLONGED DISUSE

If the appliance is to remain unused for more than 15 days proceed as follows:

- switch off the appliance and disconnect it from the electrical supply
- clean the interior of the cabinet, shelves, trays, runners and supports, paying special attention to critical areas such as articulations and magnetic sealing strips in accordance with the indications in heading 5.2.
- leave doors slightly open to prevent accumulation of residual humidity

## 5.5 PREVENTIVE MAINTENANCE

### 5.5.1 Start-up after Prolonged Disuse

Before starting the appliance after prolonged disuse perform preventive maintenance. Clean the unit thoroughly as described in heading 5.2.

### 5.5.2 Checking Warning and Control Devices

Check the correct running of the controls according to what is reported in the “Instruction and Maintenance Manual” enclosed. We recommend you to take out a service or maintenance contract with your dealer covering:

- cleaning of the condenser
- keeping a check on the refrigerant charge
- checking complete cycle operation
- electrical safety

## Section 6: SPECIAL MAINTENANCE AND REPAIRS

All maintenance work not described in the previous sections must be considered “Special Maintenance”.

Special maintenance interventions and repairs are to be performed exclusively by specialized technicians authorized by the manufacturer.

The manufacturer declines all liability in the case of work performed by the user or unauthorized persons, or if non-original spare parts are fitted to the appliance.

## Section 7: DIAGNOSTIC

In case these problems arise, please follow the instructions stated in the following chart:

PROBLEM	POSSIBLE CAUSE	SOLUTION
<b>Appliance does not switch on</b>	power failure	check plug, socket, fuses, electrical line
	other	contact technical service
<b>Refrigeration unit does not start</b>	set temperature has been reached	set new temperature
	defrosting cycle is in progress	wait for cycle to end / switch off and on again
	control panel breakdown	contact technical service
	other	contact technical service
<b>Refrigeration unit runs constantly, but does not reach set temperature</b>	room is too hot	provide better ventilation
	condenser is dirty	clean the condenser
	refrigerant needs to be recharged	contact technical service
	condensing fan is not running	contact technical service
	inefficient door seals	check seals / how goods are placed inside the cabinet
	evaporator is coated with ice	manual defrosting
<b>Refrigeration unit does not stop at set temperature</b>	control panel breakdown	contact technical service
	temperature probe breakdown	contact technical service
<b>Ice block on the evaporator</b>	improper use	see section 3.4
	defrost resistance breakdown	contact technical service
	defrost probe breakdown	contact technical service
<b>Water or ice deposits in the drip tray</b>	obstructed drain	clean the drain and the drain outlet
	refrigerated counter is not levelled	check levelling

## Chapter 8: MEAT / MEAT PANORAMA STAGIONATORE DESCRIPTION

Our MEAT / MEAT PANORAMA Stagionatore appliance has been developed to reproduce the necessary best temperature and humidity conditions to carry out meat dry-aging, regardless from environmental climate conditions.

The product has to be placed inside the appliance using the specific supplied supports, so that air can circulate freely without contact among the products.

Moreover, to obtain the best results it is advisable to carry out seasoning cycles for products as homogeneous as possible in terms of quality and size.

EVERmeat MEAT / MEAT PANORAMA control panel allows managing temperature and humidity in seasoning and storage environments.

It is equipped with a capacitive touch-screen display, combined with an advanced software and an extremely user-friendly interface for easy usage.

As a whole, it allows controlling the following functions: temperature adjustment (hot / cold) and humidity (dehumidification), defrosting (electrical), internal air recirculation for de-stratification and product oxygenation.

Main features:

- ▶ 2 pre-set recipes, programmable up to 4 phases for each recipe
- ▶ 8 completely customizable recipes to be stored on the appliance
  
- controlled parameters for each phase: temperature, humidity, fan speed, phase duration
- internal temperature and humidity are constantly visualized on display
- HACCP data and alarm recording
- alarm archive combined with warning Popup messages
- clock and calendar (RTC)
- multilingual menu
- quick setting and visualization of temperature and humidity rate
- activation/ deactivation of germicidal UV-C lamp
- visualization of value average for temperature and humidity as detected during the recipe
- module with Wi-Fi connection for remote visualization and control

## Chapter 9: INSTALLATION FIRST START

### 9.1 Installation

Before starting up the appliance, make sure that all connections have been carried out as per chapter 3.3.

### 9.2 First start

Once the appliance is plugged in, the start-up sequence will begin.

The display will show the system software loading screen for some seconds,

then the HOME starting screen.

When started, the appliance is in STOP condition with loaded recipe: Refrigerator

### 9.3 Home screen

Home screen (picture 9) is a visualization screen only, thus increasing process safety and avoiding accidental parameter/setting adjustments.

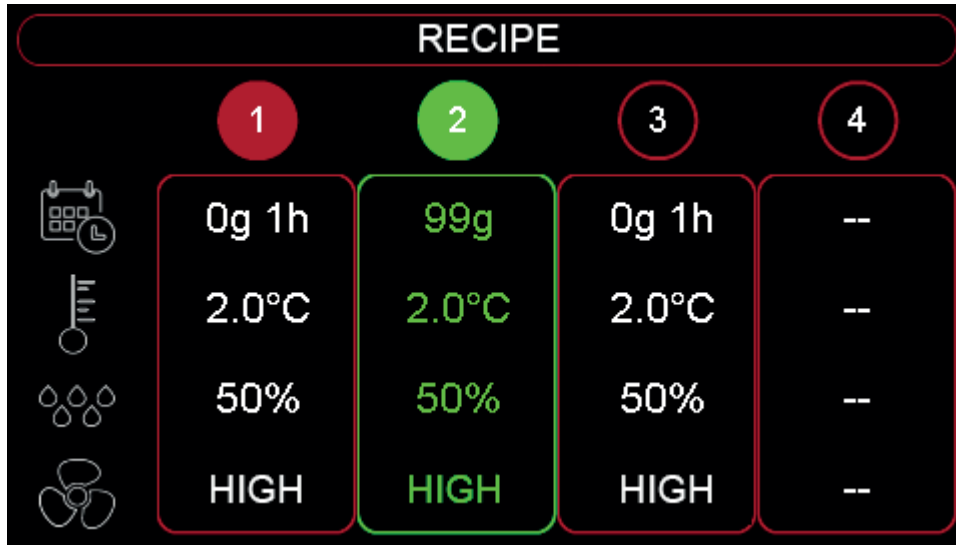

fig.9

**ATTENTION:** refer to paragraph 11.1 to adjust LANGUAGE or DATE and TIME





On the HOME screen, TEMPERATURE is displayed bottom right, whereas relative humidity detected inside the appliance is displayed bottom LEFT.

Scroll from RIGHT to LEFT on the HOME screen to visualize the RUNNING RECIPE screen



As per example above, the RUNNING RECIPE screen displays the appliance status with the progress of the 4 PHASES and their corresponding values







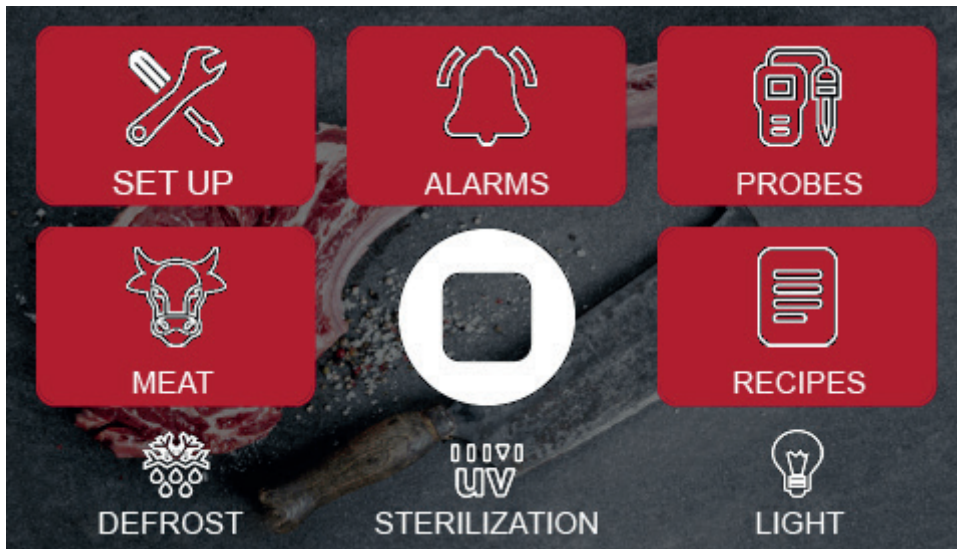

1	2	3	4
<b>CARRIED OUT PHASE</b>	<b>RUNNING PHASE (FLASHING)</b>	<b>RECIPE TO CARRY OUT</b>	<b>NOT SET PHASE --</b>

	Phase duration stated in Days, Hours.
	Temperature stated in °C centigrade degrees
	Humidity stated in % percentage
	HIGH / LOW ventilation



Scroll from LEFT to RIGHT on the HOME screen to visualize the HOT KEYS screen



 <p>SET UP</p>	<p><b>SET UP:</b> Push to access SET UP menu and set: DATE AND TIME - LANGUAGE - OUTPUTS - PARAMETERS - RESTART - INFO about current software version</p>
 <p>ALARMS</p>	<p><b>ALARMS:</b> Push to access ALARMS menu and visualize the current alarm and the stored alarms</p>
 <p>PROBES</p>	<p><b>PROBES:</b> Push to access PROBES menu and visualize the detected values of the available probes: CHAMBER TEMPERATURE - HUMIDITY - EVAPORATOR TEMPERATURE - SAFETY TEMPERATURE - PRODUCT TEMPERATURE (Opt.) - PH (Opt.).</p>
 <p>MEAT</p>	<p><b>MEAT:</b> Push to visualize the average thermo-hygrometric parameters of the running recipe</p>
	<p><b>STOP:</b> Push to INTERRUPT the running recipe</p>
 <p>RECIPES</p>	<p><b>RECIPES:</b> Push to access stored (up to 10) RECIPES menu. The first visualized recipe is number 1; scroll from right to left to visualize the remaining 9. Recipe number is displayed on the top bar.</p>
 <p>DEFROST</p>	<p><b>DEFROSTING:</b> Push to carry out MANUAL DEFROSTING (it activates only if thermo-hygrometric conditions make it necessary)</p>
 <p>STERILIZATION</p>	<p><b>STERILISATION:</b> Push to activate UV LAMPS</p>
 <p>LIGHT</p>	<p><b>LIGHT:</b> Push to turn on internal LIGHT (on glass-door models)</p>



## Chapter 10 RECIPES

Scroll from LEFT to RIGHT on the HOME screen to access the HOT KEYS screen



10.1 The Recipe Screen is divided into 3 areas

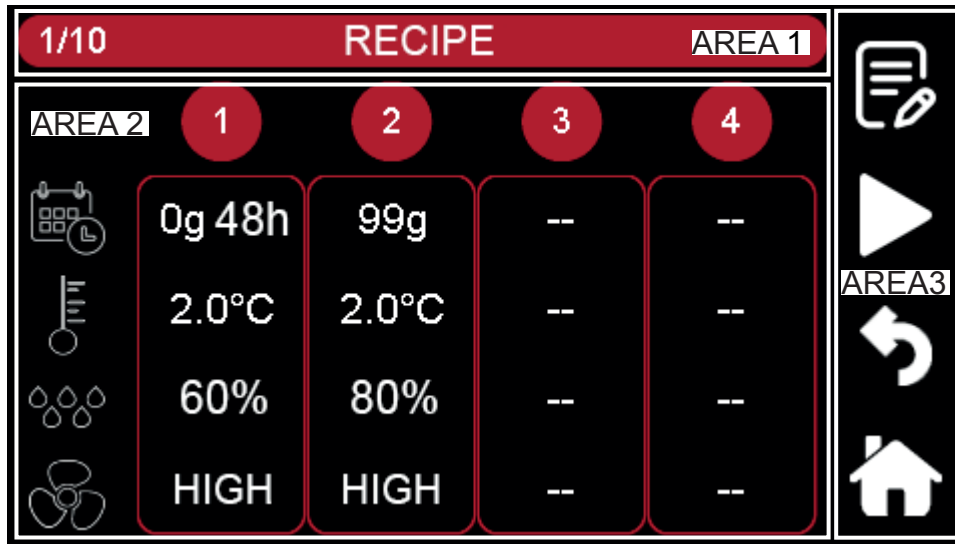

### - AREA 1:

The name and number (up to 10) of the selected recipe are displayed





The first displayed recipe is number 1/10; scroll from right to left to visualize the remaining 9

### - AREA 2:

Contains the operation parameters of the 4 available phases; each phase is clickable and opens a pop-up for value adjustment.

### - AREA 3:

AREA 3 contains the function keys allowing to carry out the following actions:

	<b>RECIPE NAME CHANGE:</b> allows changing the name of a new recipe or of an existing recipe which was previously adjusted
	<b>START:</b> allows starting the selected recipe
	<b>BACK:</b> allows returning to HOT KEYS screen
	<b>HOME:</b> allows returning directly to HOME screen

## 10.2 Start Existing Recipe

To start an existing recipe, i.e. already contained in the archive folders, scroll from LEFT to RIGHT on the HOME screen to access the HOT KEYS screen.



Access the RECIPES screen, in which there are two already pre-set recipes.

**Recipe 1:** Dedicated to the insertion of “fresh” meat with empty cabinet.

<b>Phase 1</b>	Duration 48h	Temperature 2° C	Humidity 60%
<b>Phase 2</b>	Duration 99dd (or endless cycle)	Temperature 2° C	Humidity 80%

The first phase with lower humidity % allows meat to seal quickly on the outside, so as to proceed with dry-aging in the second phase at ideal conditions.

**Recipe 2:** Daily service

<b>Phase 1</b>	Duration 99dd (or endless cycle)	Temperature 2° C	Humidity 80%
----------------	----------------------------------	------------------	--------------

This phase allows inserting meat which has already undergone dry-aging processes during a variable timeframe.

**N.B:** The present recipes are guidelines to start dry-aging. Each type of meat will have its peculiarities, such as marbling and fibres varying according to race: it will therefore be up to users to progressively calibrate set points according to their needs. We also wish to point out that a variance in the instantaneous visualization of humidity or temperature values can be considered as normal. Temperature and humidity probes reading air flow in motion can sometimes detect discordant values in relation to the set ones. We recommend considering the temperature and humidity indicated on the MEAT screen as your reference: these values represent the detected average, therefore more reliable or significant.

In case no modification of the program is necessary, just click on the START icon and confirm recipe start on the corresponding pop-up

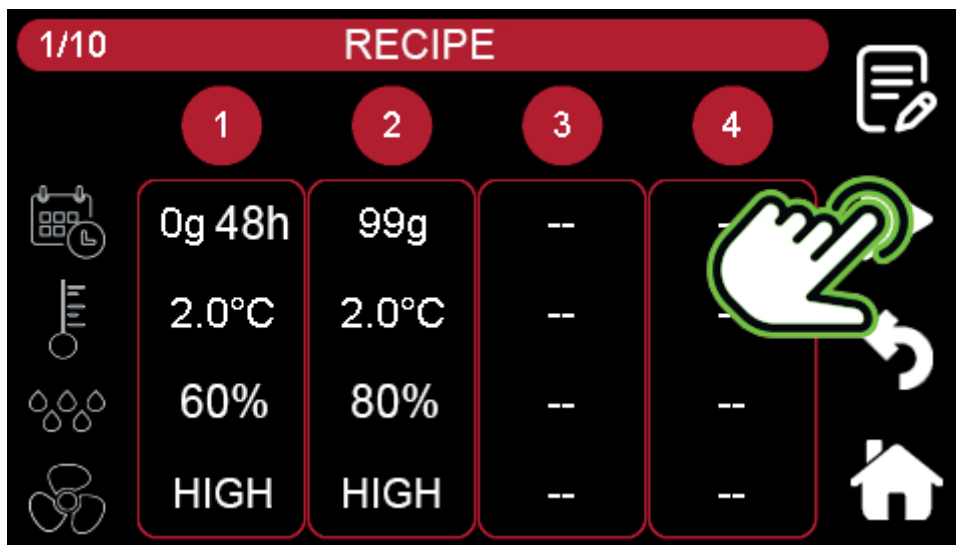



### 10.3 Existing recipe adjustment and following saving:

To modify an existing recipe, i.e. already contained in the archive folders, scroll from LEFT to RIGHT on the home screen to access the HOT KEYS screen.



Access the RECIPES screen.

To modify a recipe already present in the archive, select the column with the PHASE you wish to adjust:

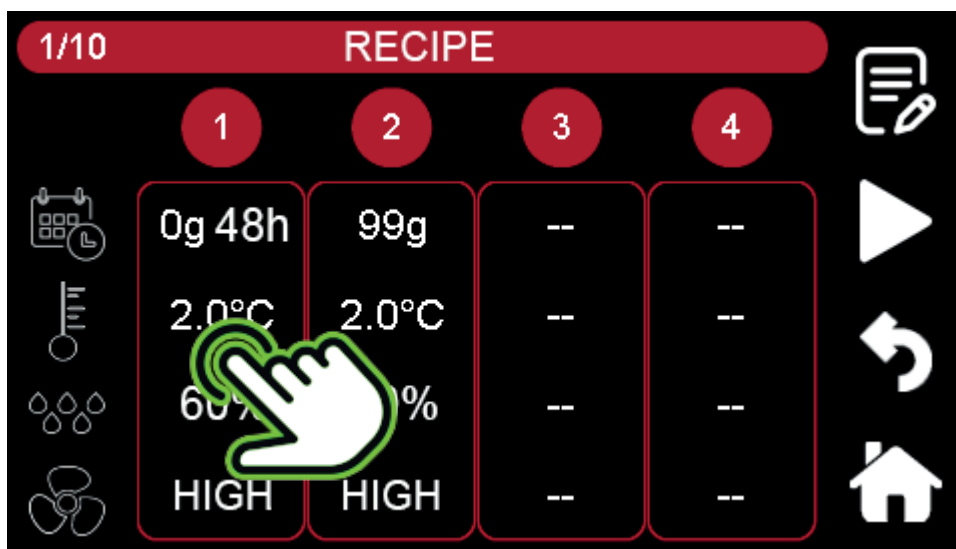

Once the PHASE is selected, a new screen will open, where it will be possible to adjust the values.





In case the PHASE is not active, we first have to activate it 



Icons will turn white and it will be possible to set the parameters; push on the corresponding icon, which will turn green, and INCREASE or DECREASE the value appearing in the middle with the corresponding side keys - and +

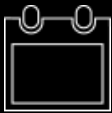

Then, we can proceed to the adjustment of phase parameters:

	- Phase duration stated in DAYS; allows setting the day duration of the selected phase
	- Duration of the phase stated in HOURS; allows setting the hour duration of the selected phase
	- Temperature stated in °C centigrade degrees; allows setting the desired internal Temperature in this phase.
	Humidity stated in % percentage; allows setting the desired internal Relative Humidity in this phase.

- HIGH / LOW ventilation speed



Ventilation control effects fan speed and consequently air movement inside the appliance.



**Low speed 80%:** specifically suitable for the second phase of long dry-aging, after meat is already externally sealed. It avoids an excessive weight loss.

**High speed 100%:** specifically indicated for the first phases after the introduction of fresh meat into the appliance; it ensures best responsiveness in temperature and humidity control, quick cooling and dry-aging start.









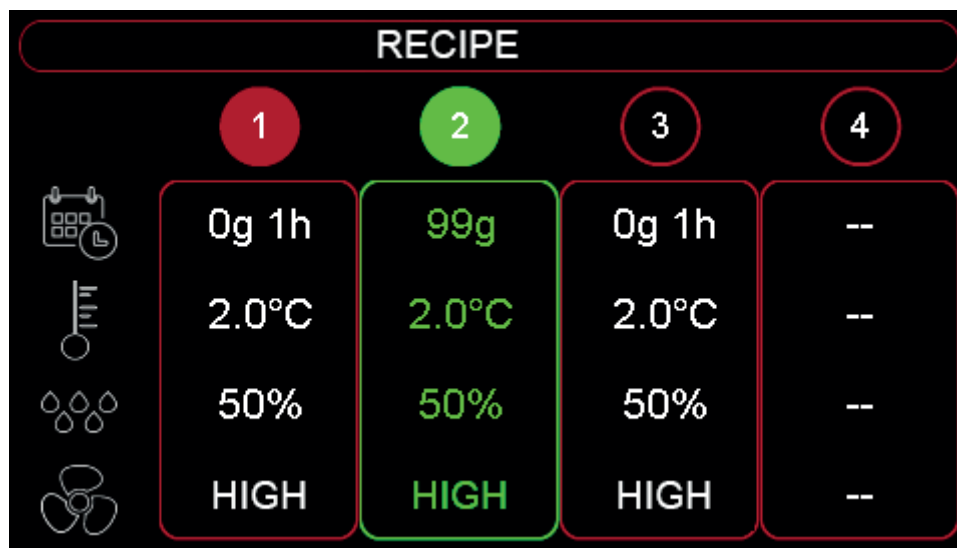

Once all adjustments are completed, push on the  key to confirm, or CANCEL  to return to the RECIPE screen.

#### 10.4 Running recipe

Scroll from RIGHT to LEFT on the HOME screen to access the running recipe screen.



From this screen, the operation status of the running recipe is controlled; in addition to the name of the recipe, the following parameters are visualized:

	Phase duration in days and hours		Carried-out phase
	Internal temperature		Running phase (flashing)
	Humidity percentage		Next phase (if active)
	HIGH/LOW fan speed		Next phase (if active)

From this screen it is possible to modify the parameters of the running recipe; the data will be saved automatically in the stored recipe.

## Chapter 11: HOT KEYS

Scroll from LEFT to RIGHT on the HOME screen to access the HOT KEYS screen.

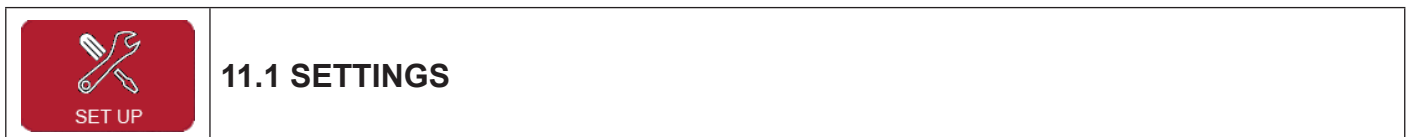

It is possible to set the following from the settings menu:

- DATE AND TIME
- RESTART
- LANGUAGE
- OUTPUTS
- PARAMETERS
- INFO





DATE AND TIME

**DATE AND TIME:** By selecting Date and Time, a Pop-up appears, allowing entering the correct values. Push on the values to be modified; then, confirm to implement the adjustments.

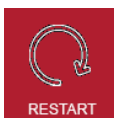
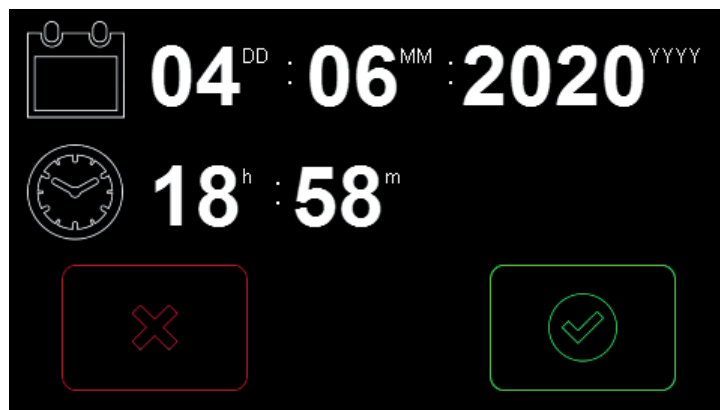

RESTART

**RESTART:** The RESTART screen it is possible to SYSTEM REBOOT (1), REBOOT the Wi-Fi connection (2) or RESET the Wi-Fi settings (3).

A warning pop-up requires user confirmation to start the operation.



LANGUAGE

**LANGUAGE:** The Language screen lists all currently available languages; select the desired one by clicking on the corresponding area. The check  icon identifies the set language.



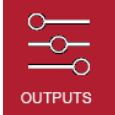

**OUTPUTS:** This page shows the status of the main outputs. The green icons represent the currently running outputs.

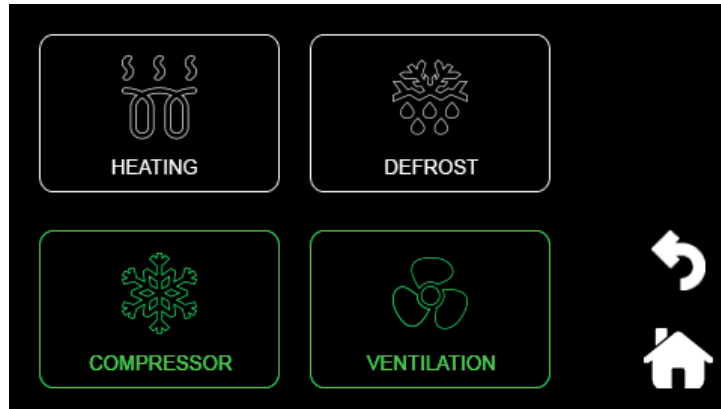

**PARAMETERS (SERVICE):** This area is protected by a password and it is exclusively intended for authorized technical personnel.

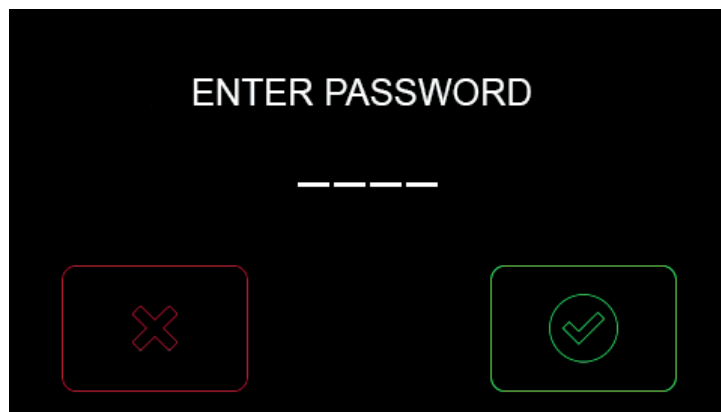

**INFO:** This page contains the hardware codes which identify the electronics installed on the appliance, as well as the installed Firmware version.

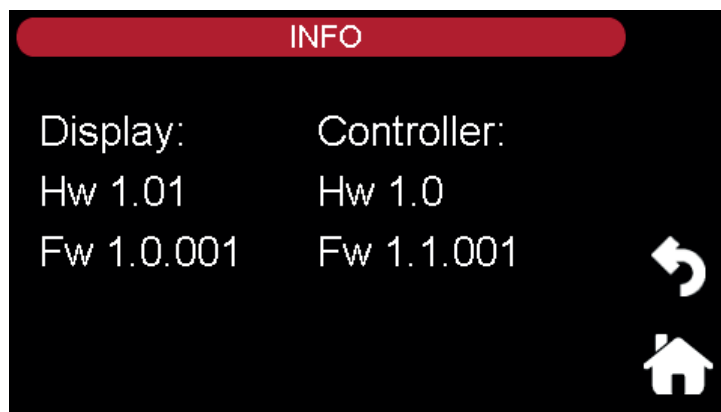







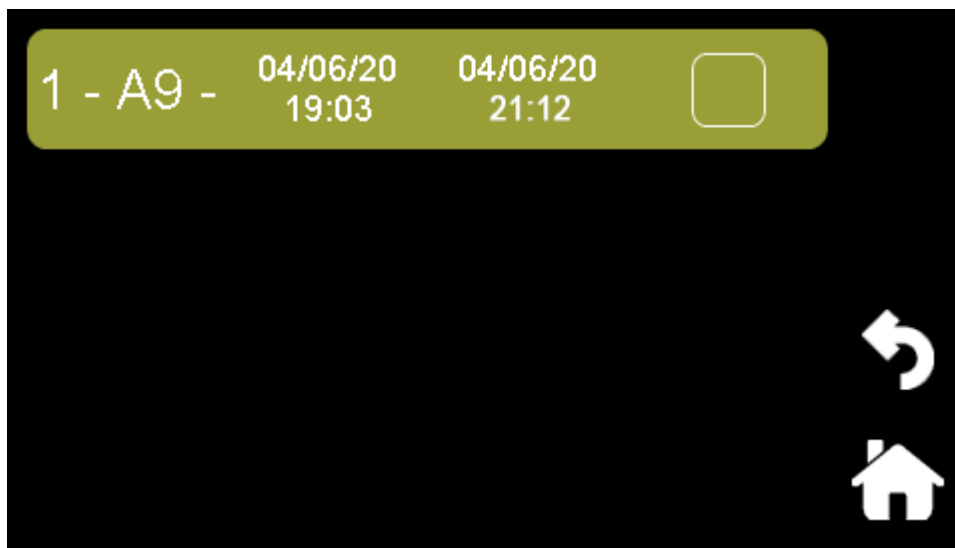

## 11.2 ALARMS

This section allows visualizing the list of all alarms that have occurred over time

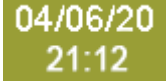

Each alarm is identified by:

 Number	Alarm progressive number	 Start date and time	When the alarm condition has occurred
 Alarm Code	Univocal identification referred to an alarm code	 Stop date and time	When the alarm condition has ceased being true

**STATUS:** there are two possible alarm statuses, each corresponding to a colour:

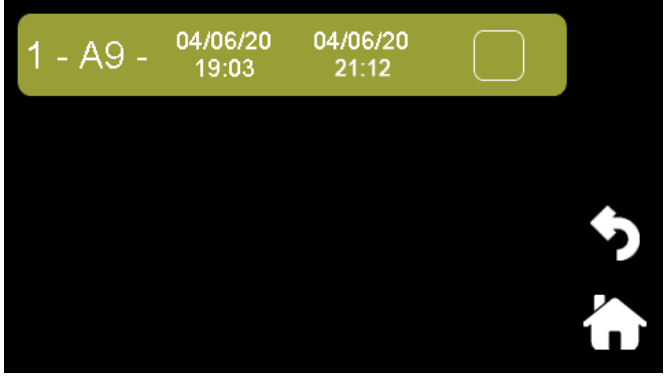
	
<p><b>Red:</b> The appliance is in alarm status; the problem has not been solved.</p>	<p><b>Yellow:</b> The appliance warns that an alarm has occurred, but now it has subsided</p>

An alarm goes from Red to Yellow status only when the condition that has generated it is no longer

verified. The alarm condition of the appliance is also visualized by a signalling pop-up on the Home screen. According to the alarm type, the appliance either continues the running process or automatically pauses, stopping any function. It is possible to cancel the whole list of recorded and recognized alarms by pushing on the CANC  function key. WARNING: it is not possible to delete a single alarm

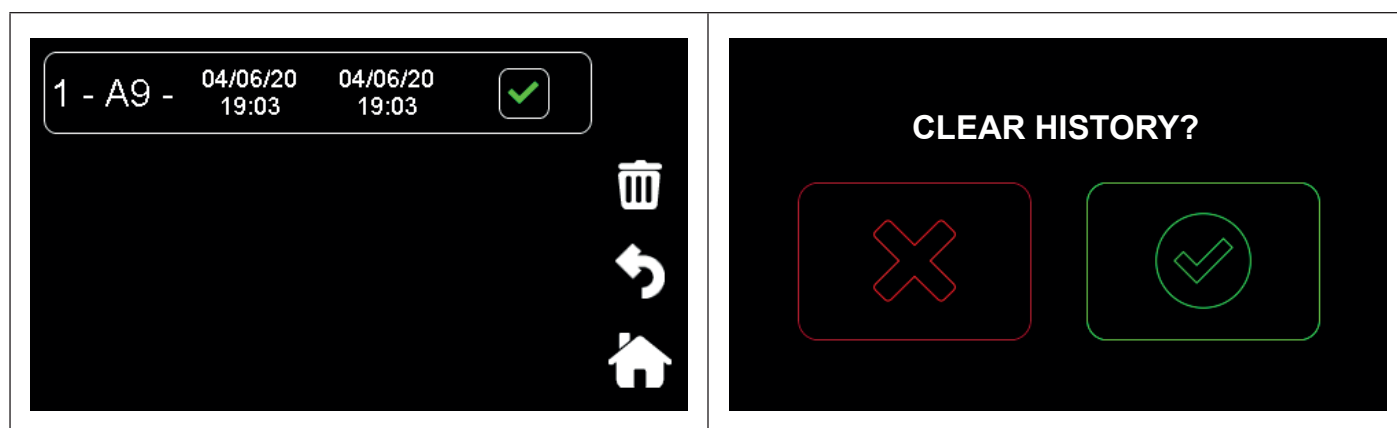

ALARM LIST			
CODE	DESCRIPTION	CAUSE	SOLUTION
A0	Low internal temperature alarm	internal chamber temperature has exceeded set low limit	faulty heater or too low set humidity
A1	High internal temperature alarm	internal chamber temperature has exceeded set limit	check refrigerating unit and internal fan functionality and clean the condenser
A2	Minimum humidity alarm	internal relative humidity degree has exceeded set minimum low limit	too low set temperature, not enough product inside the chamber, not calibrated probe
A3	Maximum humidity alarm	internal relative humidity degree has exceeded set maximum limit	not enough product inside the chamber, not calibrated probe
A4	High safety temperature alarm	evaporator chamber temperature has exceeded maximum set value	check internal fan functionality
A5	Ambient probe alarm	probe failure	replace the probe (service); then restore the alarm and restart the cycle by pushing the START key
A6	Evaporator probe alarm	probe failure	
A7	High temperature probe alarm	probe failure	
A8	Product probe alarm	probe failure	
A9	Humidity probe alarm	probe failure	
A10	Safety thermostat intervention alarm	evaporator chamber temperature has reached maximum safety value	check internal fan functionality. Once the problem is solved, reset the alarm (alarm folder), unplug the appliance and wait for some seconds before plugging it in again. The appliance will resume operating with the running recipe.

A11	Exhausted uv lamps	germicide lamp has exceeded maximum hour count (9000) expected to remain efficient	replace UV-C lamp and starter (service)
A12	Out-of-battery clock alarm	run-out battery	replace CR1220 battery



### 11.3 PROBES

This page allows visualizing the list of all probes installed on the appliance, as well as their corresponding detected value. Scroll from BOTTOM to TOP and viceversa to visualize all probes.

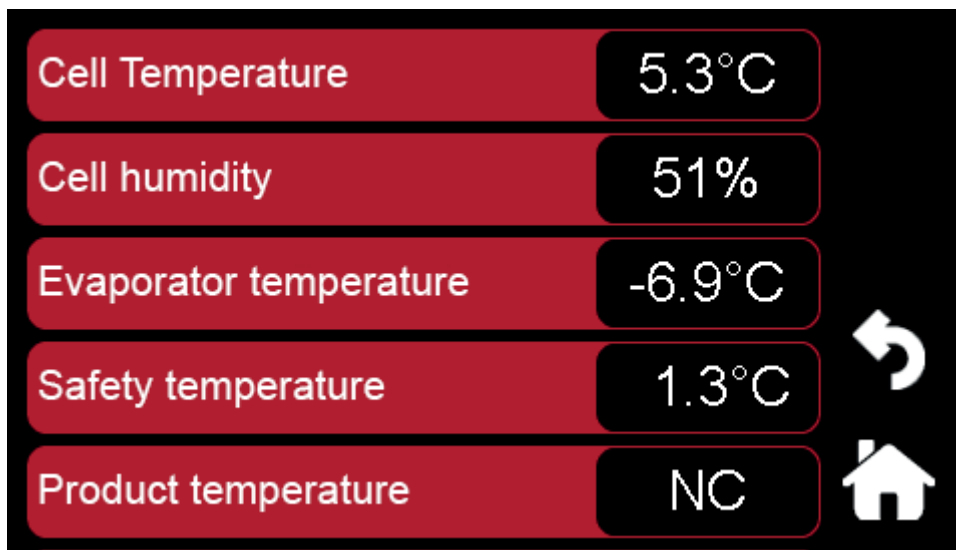

Complete Probe list:

- Chamber temperature
- Chamber Humidity
- Evaporator Temperature
- Safety Temperature
- Product Temperature (opt.)
- PH (opt.)

#### PH measurement (optional)

The pH electrode is used to control that the product is in a good condition and has the organoleptic features required by the process.

When the electrode is used for the first time: Remove the protective cap. Do not be alarmed if saline deposits are noticed: these deposits are normal and can be eliminated by rinsing the electrode with water.

During transportation, small air bubbles can form inside the glass bulb, hindering the correct operation of the electrode: they can be removed by shaking the electrode as it is done with a glass thermometer. If the bulb or the junction are dry, leave the electrode immersed in HI 70300L storage solution for at least an hour.

How to use the electrode for measurements: rinse the electrode with distilled water. Immerse the sensitive bulb for at least 4 cm into the sample to be tested, lightly shake it for around 30 seconds and wait for the reading value to stabilize.

How to store the electrode when not used: to eliminate encrustation problems and ensure quick response times, the sensitive bulb must be kept wet. Insert a few drops of HI 70300L storage solution into the protective cap.



**N.B.:** Never store the electrode in distilled water nor without protective cap.

**pH Electrode reading calibration:** These instruments tend to decalibrate over time, so they need to be calibrated regularly. If the pH-meter is used daily, it is advisable to calibrate it at least once every 15/20 measurements to ensure a better operation. A standard pH near to the unknown solution is used, so as to minimize any possible “not ideal” behaviour of the electrode. Therefore, if basic pH values are to be measured, the electrode should be calibrated by immersing it in a 7,01 sample solution; on the other hand, if acid pH values are to be measured, the electrode should be calibrated by immersing it in a 4,01 sample solution.

**Procedure:** after thoroughly cleaning the electrode, immerse it in the chosen sample solution (either 7,01 or 4,01 pH) and shake it for around 30 seconds; wait until the measured value stabilizes and then push the key on the unlocked HOME screen to access the PROBES page; read the measured pH value.

If the value is different from the one indicated on the sample solution, proceed with the calibration of the instrument.

Scroll from LEFT to RIGHT on the HOME screen to access the HOT KEYS screen; push the SETTINGS key, then the PARAMETERS key; type in the password to access the restricted PARAMETER area (Chapter 12: SETUP).

Enter the probes section of the PARAMETERS menu and select parameter P06 PH PROBE CORRECTION. Calibrate the value by typing on the numeric keyboard the difference (Positive or Negative) calculated as follows:

Difference = nominal Value (7,01 or 4,01 PH) - EVERmeat detected value

Confirm the entry and return to the HOME screen. After the calibration, rinse the electrode with distilled water, dry it and immerse it in HI 70300L product for storage.

**Cleaning the electrode:** It is advisable to carry out the cleaning of the electrode when its responses are slow or the measures are not reliable, and when it has been used for a long time, most of all with corrosive, polluting, very acid or very alkaline solutions. Choose the most suitable cleaning solution according to the type of measured solution.

Meat and cold cuts: immerse in solution HI 70630 for 15 minutes







**N.B.:** After cleaning the electrode, rinse it with distilled water.











## 11.4 MEAT

This section allows visualizing the progress status of the running recipe

RECIPE				
	1	2	3	4
	01/06/20	01/06/20	OFF	OFF
	0g 1h	2g 18h	OFF	OFF
	5.3°C	4.9°C	OFF	OFF
	54%	49%	OFF	OFF
				

In addition to the name of the recipe, the following parameters are specifically visualized:

	Day of phase start
	Phase duration in days / hours
	Detected average temperature
	Detected average humidity percentage
	Carried-out and ended phase
	Running phase (flashing)
	Next phase (if active)
	Next phase (if active)



**11.5 STOP**

This key allows stopping a running recipe by pausing it STOP, or restarting it START from the point where it was stopped.



When in STOP condition, the appliance is paused, and any functionality is stopped. Starting from a STOP condition, push START to resume the recipe from the point where it was stopped.

In case the appliance remains in STOP condition for more than 2 hours, the device goes in Stand by, which is an energy-saving mode where the display darkens and remains in STOP condition.



This screen contains all the recipes saved on the appliance

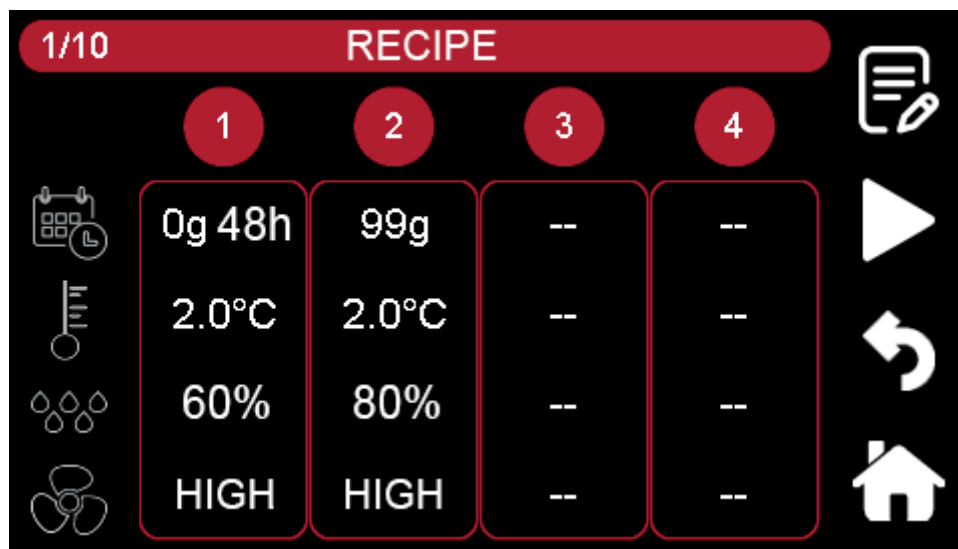

It will be possible to store up to maximum 10 recipes; there are 4 phases available for each recipe



This function allows carrying out a manual defrosting of the evaporator.

The appliance checks on the evaporator and, if needed, it carries out the defrosting, during which the phase parameters of the recipe are not controlled.



Defrosting continues automatically until end defrosting condition is reached. After that, a dripping phase starts, with which it is ensured that too wet air is not introduced into the appliance when re-started. When defrosting is active, the corresponding icon on the screen is green.

Push again on the defrosting key before its automatic end to stop it in advance; the appliance enters automatically in the final phase of dripping (signalled by the flashing hot keys icon).



### 11.8 STERILISATION

It is possible to activate or deactivate the sterilizing UV lamp operation.

Click on the UV STERILIZATION key on the HOME menu to access the selection pop-up window.

If activated, the UV lamp remains on when compressor is operating; it will be off when compressor is idle.

After 9000 operation hours the system will signal the necessity of replacing UV lamps by a pop-up message (address authorized technical personnel)

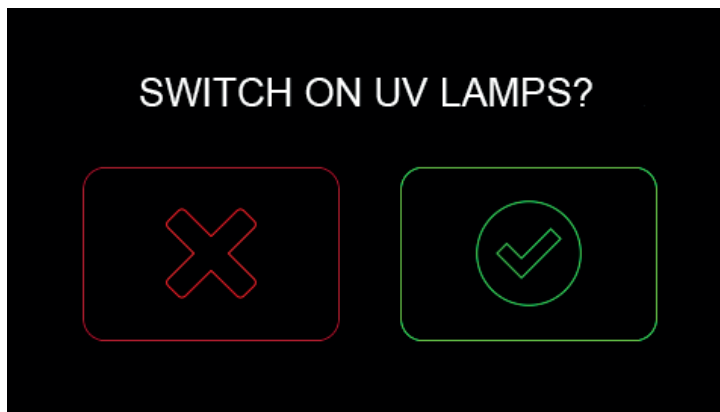

### 11.9 LIGHT

Push the light key to turn on/off the internal lighting of the appliance (glass-door models). The lights turn on automatically when the door is opened.



# **WARNING!**

**INSTRUCTIONS STRICTLY RESERVED TO AUTHORIZED  
TECHNICAL PERSONNEL**

Every intervention executed by a non authorized technical personnel  
implies a warranty decay.



## Capitolo 12: SETUP

Scroll from LEFT to RIGHT on the HOME screen to access the HOT KEYS screen

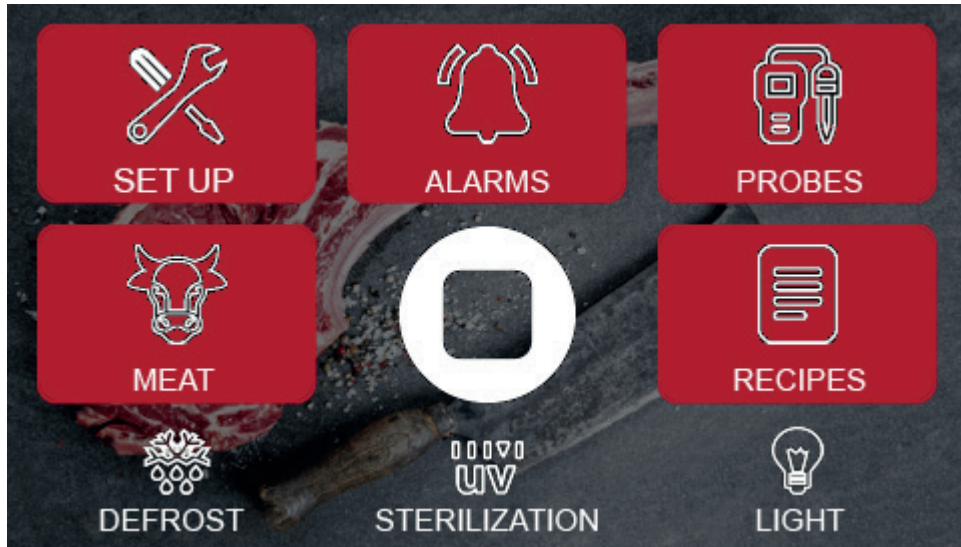

Push the SETTINGS key



Push the PARAMETERS key

This area is protected by a password, as it is intended for authorized technical personnel only.  
Type in PASSWORD: 1956 in the pop-up window



Push the  key to confirm

The **PARAMETERS** menu is composed of the following entries. Scroll from RIGHT to LEFT to access the next entries. Scroll from TOP to BOTTOM inside the entries to visualize the parameters.

<p><b>1/10 ALARMS</b></p> <p>A01 <input type="text" value="10 °C"/></p> <p>A02 <input type="text" value="5 °C"/> ↻</p> <p>A03 <input type="text" value="50 %"/> 🏠</p>	<p><b>2/10 ADJUSTMENT</b></p> <p>R01 <input type="text" value="3 °C"/></p> <p>R02 <input type="text" value="1 °C"/> ↻</p> <p>R03 <input type="text" value="10 %"/> 🏠</p>
<p><b>3/10 COMPRESSOR</b></p> <p>C01 <input type="text" value="5 m"/></p> <p>C02 <input type="text" value="10 s"/> ↻</p> <p>🏠</p>	<p><b>4/10 DEFROST</b></p> <p>D01 <input type="text" value="20 m"/></p> <p>D02 <input type="text" value="4 h"/> ↻</p> <p>D03 <input type="text" value="8 °C"/> 🏠</p>
<p><b>5/10 FANS</b></p> <p>F01 <input type="text" value="1"/></p> <p>F02 <input type="text" value="6 °C"/> ↻</p> <p>F03 <input type="text" value="1 m"/> 🏠</p>	<p><b>6/10 STERILIZATION</b></p> <p>U01 <input type="text" value="0"/></p> <p>U02 <input type="text" value="180 m"/> ↻</p> <p>U03 <input type="text" value="60 m"/> 🏠</p>
<p><b>7/10 SETTINGS</b></p> <p>E01 <input type="text" value="0"/></p> <p>E02 <input type="text" value="1"/> ↻</p> <p>E03 <input type="text" value="1"/> 🏠</p>	<p><b>8/10 CONFIGURATION</b></p> <p>X01 <input type="text" value="1"/></p> <p>↻</p> <p>🏠</p>
<p><b>9/10 DISPLAY</b></p> <p>H01 <input type="text" value="0"/></p> <p>↻</p> <p>🏠</p>	<p><b>10/10 PROBES</b></p> <p>P01 <input type="text" value="0 °C"/></p> <p>P02 <input type="text" value="0 °C"/> ↻</p> <p>P03 <input type="text" value="0 °C"/> 🏠</p>

PARAMETER CHART 07-2020			
N°	ALARM DESCRIPTION	VAL.	RANGE
A01	Differential regarding temperature set for alarm	10°C	+2;+45°C
A02	Hysteresis for temperature set alarm respite	5°C	+1;+45°C
A03	Differential regarding humidity set for alarm	50%	2;50%
A04	Hysteresis for humidity set alarm respite	20%	1;50%
A05	Alarm warning activation delay	60 m	0;99m
A06	Maximum safety temperature value	55	0;99°C
A07	Germicidal UVC lamp maximum duration	9000	2;30000 h
<b>ADJUSTMENTS</b>			
R01	Differential regarding set for compressor ON	3°C	+1;+45°C
R02	Differential regarding set for heating ON	1°C	+1;+45°C
R03	Differential regarding humidity set for dehumidification ON	10%	1;50%
R04	Hysteresis for dehumidification ON-OFF	5%	0;50%
R05	Minimum temperature set point	-2°C	-10;+30°C
R06	Maximum temperature set point	10	0;+45°C
R07	Minimum humidity set point	40%	10;60%
R08	Maximum humidity set point	90%	40;90%
<b>COMPRESSOR</b>			
C01	Compressor restart delay after OFF	5 m	0;15m
C02	Delay at appliance start	10 s	1;50s
<b>DEFROSTING</b>			
D01	Maximum defrosting duration	20 m	1;99m
D02	Defrosting interval	4 h	0;48h
D03	Defrosting end Setpoint	8°C	-35;+45°C
D04	Dripping duration	2 m	0;60m
<b>VENTILATION</b>			
F01	Operation mode 0=always ON 1=controlled	1	0;1
F02	Evaporator temperature for fans ON (cold call only)	6	-10;+30°C
F03	Fan turning-off delay after heating	30 s	0;120 s
F04	Adjustment percentage for low speed	80%	40;90%
F05	Adjustment percentage for high speed	99%	70;100%
F06	ON OFF fan time in dehumidification	30 s	5;360s
F07	OFF OFF fan time in humidification	60 s	5;360s
<b>UV</b>			
U01	Operation mode 0=continuous ON 1=cyclic  <b>Note:</b> If activated, the UVC lamp is normally connected to compressor operation with operation mode <b>U01 = 0</b>  It is possible to time-set the turning-on of UVC lamp during its activation with running compressor with operation mode <b>U01 = 1</b> Subsequently set turning-on and turning-off time by adjusting parameters <b>U02</b> and <b>U03</b>	0	0;1
U02	ON lamp time for cyclic mode	30 m	1;9999m
U03	OFF lamp time for cyclic mode	360 m	1;9999m
<b>SETTINGS</b>			
E01	Activate product probe	0	0;1
E02	Activate high temperature safety probe	1	0;1

E03	Activate germicidal UVC lamp	1	0;1
E04	Activate alarm signalling buzzer	1	0;1
E05	Activate PH probe	0	0;1
E06	Reserved	0	0;1
	<b>CONFIGURATIONS</b>		
X01	Microswitch contact 0=NC 1=NO	0	0;1
	<b>DISPLAY</b>		
H01	Language	0	0;4
	<b>CALIBRATIONS</b>		
P01	Ambient probe correction	0	-10;+10°C
P02	Evaporator probe correction	0°C	-10;+10°C
P03	High temperature safety probe correction	0%	-10;+10°C
P04	Product probe correction	0°C	-10;+10°C
P05	Humidity probe correction	0°C	-20;+20°C
P06	PH probe correction	0	-10;+10

### Chapter 13: FIRMWARE UPDATE

Contact service

### Chapter 14: GERMICIDAL UVC LAMP REPLACEMENT

UV lamps must be replaced after around 9000 working hours. An alarm POP-UP will indicate that replacement is needed. This operation must be carried out only by specialized personnel with the manufacturer's authorization, as the light of ultraviolet ray lamps can damage the skin and the eyes.

Before replacing the U.V. lamps, enter menu

SETTINGS

PARAMETER (password 1956)

select parameter A07 (UVC lamp maximum duration) and type in value 0.

Exit the menu by pushing the HOME key.

Enter the ALARM menu, select alarm A11 (exhausted lamps) and confirm its acknowledgement.

Exit the menu by pushing the HOME key.

Turn off the appliance by unplugging it; replace the lamps and the ignition starter.

Plug in the appliance and enter menu









EVERLASTING

EVERLASTING s.r.l.  
46029 SUZZARA (MN) - ITALY - Strada Nazionale della Cisa km.161  
Tel.0376/521800 (4 linee r.a.) - Telefax 0376/521794  
<http://www.everlasting.it> - E-mail:[everlasting@everlasting.it](mailto:everlasting@everlasting.it)