

Use and maintenance manual

EVERLASTING

BLAST CHILLERS / SHOCK FREEZERS

PROFESSIONAL TRAY



Thank you for choosing this product.

Please read the warnings contained in this manual carefully, as they provide important information regarding safe operation and maintenance.

Make sure to keep this manual for any future reference by the various operators.

In some parts of the manual, the  symbol appears, indicating an important warning that must be observed for safety purposes.

CHAPTER 1 BOUNDARY CHARACTERISTICS OF OPERATION

The blast chiller has been designed and built to operate in optimal conditions at temperatures of up to +43°C, with adequate air circulation. In places with characteristics that are different from the requirements, the stated performance cannot be guaranteed.

Standard power voltage for models PROFESSIONAL TRAY 05 - 07 is 230V/50Hz; for models PROFESSIONAL TRAY 10 - 15 - 20 is 400V/3N-Ph/50 Hz or the one indicated on CE label.

The following table shows the cooling and/or freezing capacity in kg.

Model	Blast chilling Kg. +90°C / +3°C	Rapid freezing Kg. +90°C / -18°C
PROFESSIONAL TRAY 05 P	20	14
PROFESSIONAL TRAY 07 P	25	18
PROFESSIONAL TRAY 10 P	35	25
PROFESSIONAL TRAY 15 P	55	40
PROFESSIONAL TRAY 20 P	75	55

N.B.: the times and quantities in kg above are valid for products with a maximum thickness of 4 cm.

Maximum time: Positive chilling: 90 min, Freezing: 240 min

The technical features of blast chillers PROFESSIONAL TRAY 05 - 07 - 10 - 15 - 20 are listed on the CE label placed on the rear side of the body.

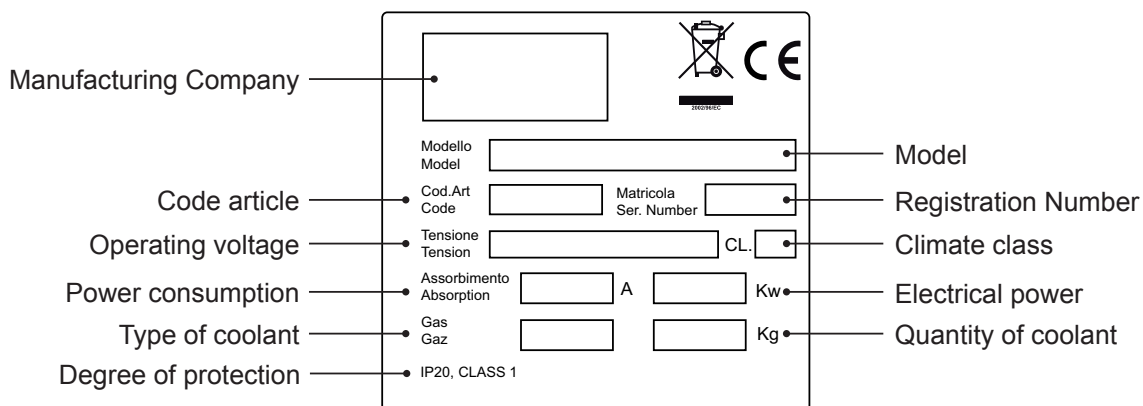



 **ATTENTION:** any request for intervention, technical support and spare part must refer to the **SERIAL NUMBER** on the CE label, on the manual cover or on the compressor motor. The producer declines any responsibility for any improper or not reasonably foreseen usage of the blast chiller and for any operation carried out by neglecting the indications listed on the manual. The manufacturer declines any liability for improper use of the blast chiller, as well as use that could not have been reasonably foreseen, and for all operations performed on it that disregard the instructions in the manual.

The main general safety standards are listed below:

- Do not use or place electrical devices inside the refrigerated compartments if they are not of the type recommended by the manufacturer
- Do not touch the blast chiller with damp or wet hands or feet
- Do not use the blast chiller barefoot
- Do not insert screwdrivers or other objects between the guards or moving parts
- Do not pull the power cord to unplug the blast chiller from the electricity network
- The blast chiller is not intended to be used by persons (including children) with physical or mental problems, or lack of experience and knowledge, unless they are controlled or instructed in using the unit by a person responsible for their safety. Children must be supervised to ensure that they do not play with the appliance.
- Before carrying out any cleaning or maintenance, disconnect the blast chiller from the mains power supply by turning off the main switch and pulling the plug
- In the event of failure and/or malfunction of the blast chiller, turn it off and to refrain from any attempt to repair or intervene directly. It is necessary to exclusively contact a qualified technician.

Blast chiller model PROFESSIONAL TRAY is composed of a modular single body insulated with expanded polyurethane with 42 kg/m³ density, internally covered in Stainless Steel AISI 304 and externally by different materials. In the design and construction, all measures have been adopted to ensure a blast chiller that complies with safety and hygiene requirements, such as: rounded interior corners, deep drawing with drain on the outside for the condensate liquids, no rough surfaces, fixed guards on moving or dangerous parts. The products must be stored in observance of the load limits given in the table, in order to ensure an efficient circulation of air inside the blast chiller.

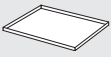
Load capacity BLAST CHILLERS PROFESSIONAL TRAY

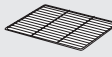
PROFESSIONAL TRAY	Capacity		
	 GN 1/1	 SLT	
Mod.	Nr°	Nr°	Nr°
PROF. TRAY 05	5 Passo 70 mm.	6	2
	6 Passo 52,5 mm.		
	9 Passo 35 mm.		
PROF. TRAY 07	7 Passo 70 mm.	9	3
	9 Passo 52,5 mm.		
	13 Passo 35 mm.		
PROF. TRAY 10	10 Passo 70 mm.	12	4
	13 Passo 52,5 mm.		
	19 Passo 35 mm.		
PROF. TRAY 15	15 Passo 70 mm.	18	6
	20 Passo 52,5 mm.		
	30 Passo 35 mm.		
PROF. TRAY 20	21 Passo 70 mm.	24	8
	27 Passo 52,5 mm.		
	41 Passo 35 mm.		



The installation must be performed exclusively by a qualified technician

1.1 It is prohibited to remove the guards and safety devices

It is absolutely forbidden to remove safety guards.

The manufacturer disclaims any liability for accidents due to failure to comply with this obligation.

1.2 Information on emergency operations in the event of fire

- disconnect the Blast chiller from the power source or cut off the power supply
- do not use water jets
- use dry chemical or CO2 extinguishers

CHAPTER 2 CLEANING THE REFRIGERATOR

Since the blast chiller will be used to store food, cleaning is necessary for hygiene and health protection purposes. The cleaning of the blast chiller has already been carried out at the factory. It is suggested, however, to carry out an additional cleaning of the internal parts before use, making sure that the power cord is unplugged.

2.1 Cleaning the interior and exterior cabinet

For this purpose the following are indicated

- the cleaning products: water and mild, non-abrasive detergents. **DO NOT USE SOLVENTS AND THINNERS**
- methods for cleaning: wash the interior and exterior parts with warm water and mild soap or with a cloth or sponge with suitable products
- disinfection: avoid substances that can alter the organoleptic characteristics of the food
- rinsing: cloth or sponge soaked in warm water. **DO NOT USE WATER JETS**
- frequency: weekly is recommended, the user can set different frequencies depending on the type of food being stored.



REMARK: Clean frequently the door seals.

Some preserved products could release some enzymes that could damage the seals causing its quick deterioration. For the cleaning, use only specific products for this purposes, available also on request on our sales network.

2.2 Cleaning the condenser

The efficiency of Blast chillers is compromised by condenser / remote condensing unit obstruction; therefore, it is necessary to clean it monthly. Before carrying out this operation, turn off the Blast chiller / remote condensing unit, disconnect the power cable and proceed as follows:

Motor at the bottom – open the front control box by unscrewing the specific screws and by turning it on the lower hinges.

Motor at the top- for models with non-flippable fixed front, use a safe stepladder and directly access the condenser, placed on the upper part of the Blast chiller.

Remote condensing unit – according to the model, remove the condenser protection as per instructions on the supplied unit manual.

Remove dust and lint from the wings by vertical movements with the help of an air jet or a dry brush. In case of oily deposits, use a brush imbibed with specific detergents. For models with flippable fronts, unscrew the block screw and turn the front by the top hinges; proceed then with cleaning as for models with fixed front. After completing the operation, restart the Blast chiller. Evaporators installed above the appliances are cathaphoresis-treated to reduce corrosion problems.



During this operation, use the following personal protective equipment: goggles, respiratory protection mask, chemically resistant gloves (gasoline-alcohol).

CHAPTER 3 PERIODIC CHECKS TO BE CARRIED OUT

The following are the points or units of the blast chiller that require periodic checks:

- integrity and efficiency of door seals
- integrity of the grilles in contact with food
- integrity of the fixing hinges of the doors
- integrity of the power cord of the blast chiller

3.1 PRECAUTIONS IN CASE OF LONG PERIODS OF INACTIVITY

A long period of inactivity is defined as a stoppage of more than 15 days.

It is necessary to proceed as follows:

- switch off the blast chiller and disconnect it from the power supply
- carry out a thorough cleaning of the interior cabinet, shelves, trays, guides and supports, paying special attention to critical points such as the joints and magnetic gaskets, as indicated in Chapter 2.
- leave the door partly open to prevent air stagnation and residual humidity

CHAPTER 4 PREVENTIVE MAINTENANCE

4.1 Restarting after a long period of inactivity

Restarting after long inactivity is an event that requires preventive maintenance.

It is necessary to perform a thorough cleaning as described in chapter 2.

4.2 Control of the warning and control devices

We recommend that you contact your dealer for a service or maintenance contract that includes:

- cleaning of the condenser
- verification of the coolant load
- remote condensing unit condenser cleaning
- verification of the full cycle operation
- electrical safety



CHAPTER 5 EXTRAORDINARY MAINTENANCE AND REPAIR

All maintenance activities that have not been described in previous chapters are considered "Extraordinary Maintenance." Extraordinary maintenance and repair are tasks reserved exclusively to the specialist personnel authorized by the manufacturer.

No liability is accepted for actions carried out by the user, by unauthorized personnel, or with the use of non-original replacement parts.

CHAPTER 6 TROUBLESHOOTING

Problems may occur, in the blast chiller, identified as shown in the table:

TROUBLE DESCRIPTION	POSSIBLE CAUSES	HOW TO REPAIR IT
the blast chiller does not turn on	no power supply	check the plug, socket, fuses, line
	other	contact technical support
the refrigeration unit does not start	the set temperature has been reached	set new temperature
	defrosting in progress	wait until the end of cycle / turn power off and on again
	control panel failed	contact technical support
	other	contact technical support
the refrigeration unit runs continuously but does not reach the set temperature	location is too hot	aerate more
	condenser is dirty	clean the condenser
	insufficient coolant	contact technical support
	stop the condenser fan	contact technical support
	insufficient sealing of doors	check the seals / provision of goods
	evaporator completely frosted	manual defrosting
	other	contact technical support
the refrigeration unit does not stop at the set temperature	command panel failed	contact technical support
	temperature sensor ceiling failed	contact technical support
block of ice on the evaporator	misuse	see chapter 1.
	defrost heater fault	contact technical support
	defrost probe damaged	contact technical support
accumulation of water or ice in the drip tray	drain clogged	clean the pipette and the drain
	blast chiller is not level	check levelling

CHAPTER 7 INSTRUCTIONS FOR REQUESTING ASSISTANCE

For any technical problem and for intervention, assistance and spare-part requests it is necessary to exclusively revert to one's dealer, providing the code and the serial number indicated on the specification label attached to the appliance.

CHAPTER 8 SAFETY AND ACCIDENT PREVENTION

The blast chiller has been built with suitable measures to ensure the safety and health of the user. The following are the measures taken to protect against mechanical risks:

- **stability:** The blast chiller, even with the grilles removed, has been designed and built in such a way that under the intended operating conditions, its stability is suitable for use without risk of overturning, falling or unexpected movement
- **surfaces, edges, corners:** the accessible parts of the blast chiller are, within the limits allowed by their functions, free of sharp angles and sharp edges, as well as rough surfaces likely to cause injury
- **moving parts:** were designed, constructed and arranged to avoid risks. Certain parts are equipped with fixed guards so as to prevent risks of contact which may result in injury

The following are the measures taken to protect against other risks:

- **electricity:** The blast chiller has been designed, built and equipped so as to prevent risks from electricity, in accordance with the specific legislation in force
- **noise:** The blast chiller has been designed and built in such a way that risks resulting from the emission of airborne noise are reduced to the minimum level

8.1 safety devices adopted

It is absolutely forbidden (Fig. 2):

- tamper with or remove the condensing unit cover casing
- to tamper with or remove the evaporator housing casing that protects the user against the risk of being cut by the evaporator fins and the movement of the internal fan
- remove the labels specifying the technical features and the warnings for ground connection of the condensing unit
- remove the labels applied at the inner edge of the engine compartment, showing the technical specifications (1) and the instructions for grounding (2)
- remove the condensing unit label warning to cut off the power supply before operating on the appliance
- remove the label applied on the evaporator guard and near the electrical wiring inside the engine compartment, which warns the user to turn off the power supply before working on the unit (3)
- to remove the labels applied inside the engine compartment, indicating grounding (4)
- to remove the label applied on the power cord, indicating the type of power supply (5)

The manufacturer declines any responsibility for the safety of the blast chiller if this were to happen.

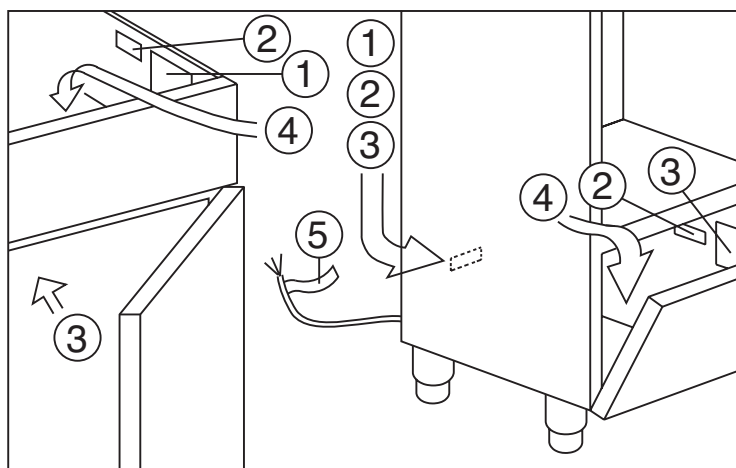

Fig.2



8.2 Indications for optimal operation

- do not obstruct the motor-compartment air intakes (place at minimum 50 cm from ceiling)
- do not block the air vents of the engine compartment
- place the foodstuffs on the appropriate shelves or containers. Do not place them directly on the bottom, or leaning against the walls, doors or fixed guards
- close the doors carefully
- always keep uncluttered the defrosting water drain hole placed on the bottom
- always keep the defrost water drain hole clear of obstructions
- limit, to the extent possible, the frequency and duration of door opening. Each opening causes a change in the internal temperature
- perform periodically current maintenance (see chapter 3)

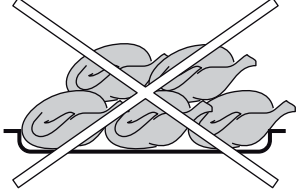

ENGLISH

CORRECT LOAD THE BLAST CHILLER

AVOID overloading the blast chiller beyond the set limits shown in the table

NO	OK
	

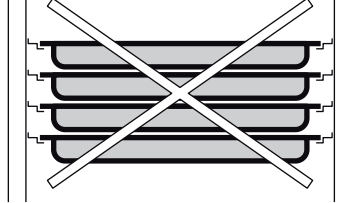
Do not place the trays too close to each other so as to avoid uneven air circulation inside the blast chiller

NO	OK
	

Do not place the trays too far away from the evaporator

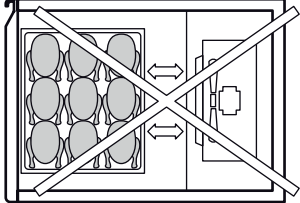
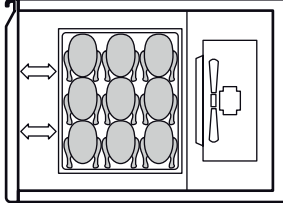
NO	OK
	

Do not concentrate the trays in one area of the blast chiller in case the load is not complete; distribute its height evenly

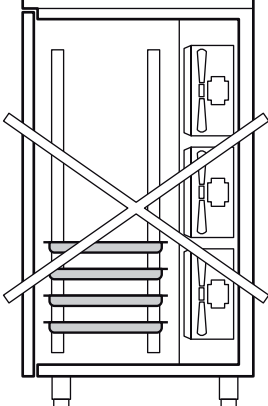
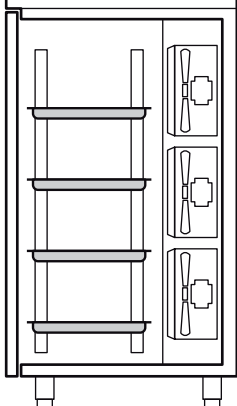
NO	OK
	

In case of interruption or failure of the power supply circuit, prevent the opening of the doors in order to maintain a uniform temperature inside the blast chiller.

If the problem persists longer than a few hours it is recommended to move the product to a suitable place.

9.1 Control panel description:

the Blast chiller control panel is a digital thermoregulator with 5-inch capacitive touch-screen graphic display.

HOME screen

The available operation statuses are:

- **OFF** control panel is off
- **STAND-BY** control panel is powered and turned off
- **ON** control panel is powered, turned on and waits for an operation cycle to start
- **RUN** control panel is powered, turned on and an operation cycle is running.

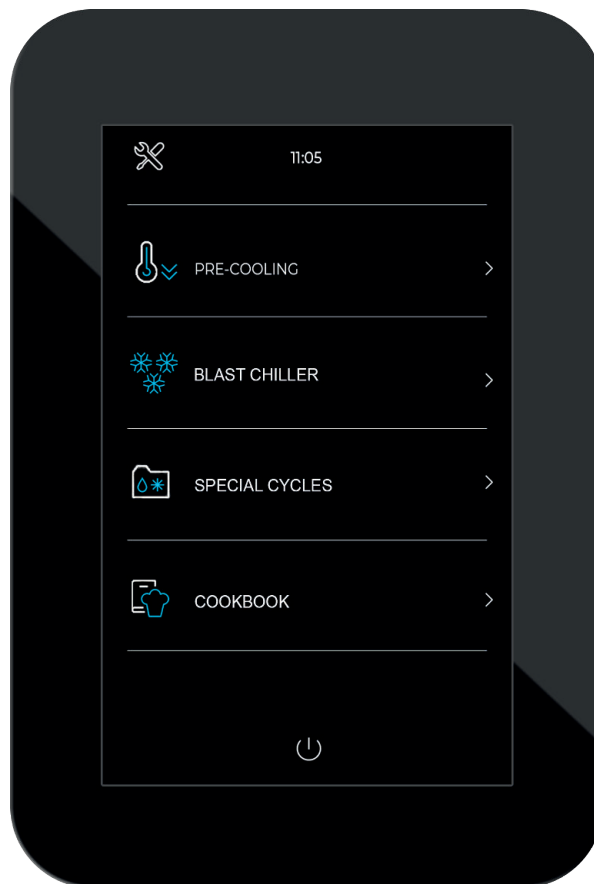

In case of power interruption during “STAND-BY” or “ON” status, when power will be restored the control panel will resume the current status before the interruption.

In case of power interruption during “RUN” status, when power will be restore the Blast chiller will operate as follows:

- if blast-chilling or shock-freezing was running, the cycle will be restored by taking into consideration the duration of the power shortage;
- if **STORAGE** was running, the cycle will continue with the same settings;
- if **LEAVENING** or **SLOW COOKING** was running, the cycle will be resumed from the point where it was interrupted.

9.2 INSTRUCTIONS FOR USE

9.2.1 Start-up

Before starting up the Blast chiller, make sure that electrical connections have been carried out as indicated on chapter 14.

Plug in the Blast chiller; the display will turn on and will show the status it was in before unplugging it, i.e.:

On/stand-by screen: push on the central area to go to **HOME** screen;
 - directly on **HOME** screen , displaying the operation menus.

ON/STAND-BY



HOME



If the duration of the power shortage has caused a clock error, it will be necessary to reset real dat and time (Chapter 10)

- Push the central key on the On/stand-by screen to turn on the control panel: **HOME** screen will be displayed.

- Push the key at the bottom of the **HOME** screen to turn off the control panel.

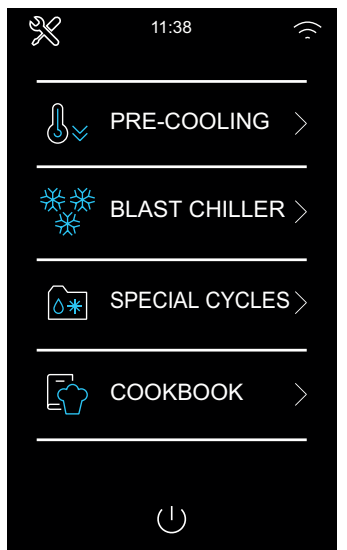

9.2.2 Silencing the buzzer

Push any key while the buzzer rings.

9.2.3 Open door warning

- The following warning is displayed when the door is opened
- Push any area on the display to remove the visualization.

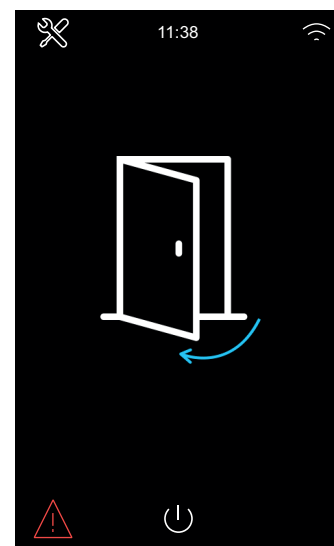

9.3 OPERATION

The appliance can manage the following operation cycles:

- **Temperature-based blast chilling and storage**
- **Temperature-based hard blast chilling and storage**
- **Time-based blast chilling and storage**
- **Time-based hard blast chilling and storage**
- **Temperature-based shock freezing and storage**
- **Temperature-based soft shock freezing and storage**
- **Time-based shock freezing and storage**
- **Time-based soft shock freezing and storage**
- **Multitimer continuous cycle**
- **Precooling**
- **Sanification**
- **Thawing (optional)**
- **Defrosting**
- **Ice-cream hardening**
- **Chocolate**
- **Drying**
- **Sterilisation (optional)**

The following additional functions are available on models **MULTIFUNCTIONAL PROFESSIONAL TRAY**:

- **Retarding-Proofing**
- **Slow cooking**

9.3.1 OPERATION MODE selection

Choose the operation mode by selecting the corresponding key on the **HOME** screen.



	<p>Allows selecting a chamber precooling cycle</p>
	<p>Allows activating Blast chiller mode</p>
	<p>Allows activating special cycle mode</p>
	<p>Allows selecting recipe model, where prestored recipes are available</p>

	<p>The icon appears in case of running alarms.</p>
	<p>Push to visualize the archive of alarms detected during operation;</p>

9.3.2 BLAST-CHILLING / SHOCK-FREEZING cycle selection

- Push the key on the **HOME** screen to select a **BLAST-CHILLING** or **SHOCK-FREEZING** cycle

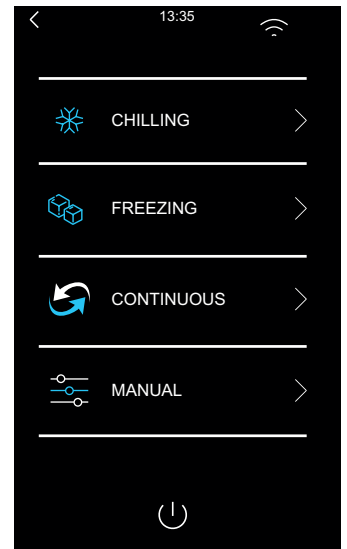

It will be possible to select one of the following functions:

	<p>BLAST CHILLING: allows selecting a standard blast chilling cycle with its specific presets. It is possible to select the HARD mode on the same screen: in this case, blast chilling is composed of two phases with different setpoints. At the end of blast chilling, the corresponding storage phase is carried out with specific setpoints according to the selected blast-chilling type.</p>
	<p>SHOCK FREEZING: allows selecting a standard shock freezing cycle with its specific presets. It is possible to select the SOFT mode on the same screen: in this case, shock freezing is composed of two phases with different setpoints. At the end of shock freezing, the corresponding storage phase is carried out with specific setpoints according to the selected shock-freezing type.</p>
	<p>CONTINUOUS CYCLE: allows selecting and endless blast-chilling/ shock-freezing cycle with the possibility of inserting various operation timers.</p>
	<p>MANUAL CYCLE (CUSTOMIZED): Push the key to start the procedure to set a customized cycle. It is possible to create up to 4 phases in this cycle. Once all phases are set, the cycle can be started or the set program can be saved inside the recipe list.</p>

- BLAST CHILLING/SHOCK FREEZING AND STORAGE

CHILLING > FREEZING >

Push on these areas to respectively go to a **BLAST-CHILLING** or **SHOCK-FREEZING** cycle: the following screen with active “core probe” key  is displayed.

NOTE: if the core probe is present and not in error, the default cycle is always **TEMPERATURE-BASED**.

- Push the  key to go to a **TIME-BASED CYCLE**: the core probe key will deactivate and the **TIME** key will activate.

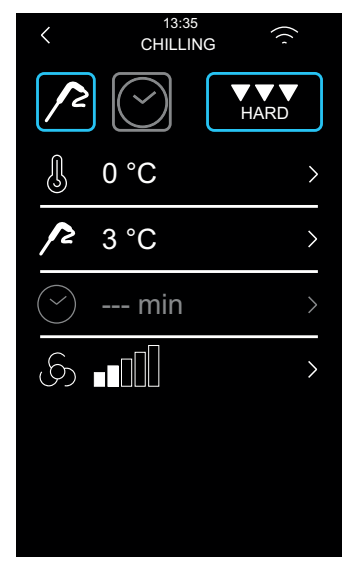

The selected cycle will propose the preset settings for that cycle

- Push the  key to adjust the preset settings within the allowed ranges.

- Push the  key to activate the EXPERT MODE and adjust all setpoints of the various non-visible phases foreseen for the selected cycle.

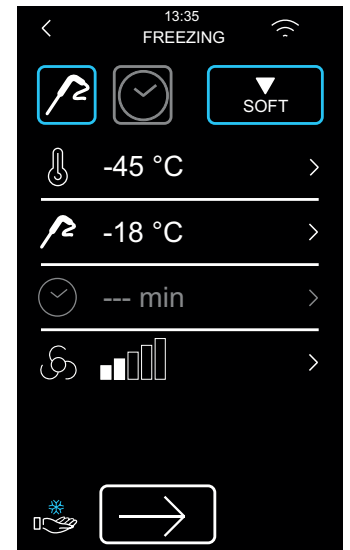

- Once all settings are completed, push  to end the phase: a summary screen with data regarding the set cycle will be displayed, as shown here below.

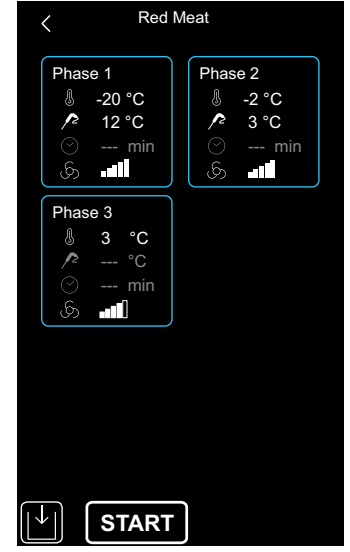

Push the  key to save the set program, or  to start the cycle.

If the cycle is **TEMPERATURE-BASED**, a test to check the correct insertion of core probe inside the product will be carried out. If the test is not passed, the cycle automatically becomes **TIMED-BASED**: the buzzer rings and the running alarm symbol will be displayed.

- During the execution of the cycle, the main setpoints will be displayed.

Push the  key to visualize the temperature trend chart with 5-minute sampling, except when cycle is resumed after a power shortage and after the start of a storage phase.

It is possible to stop the cycle at any one time by pushing the  key.

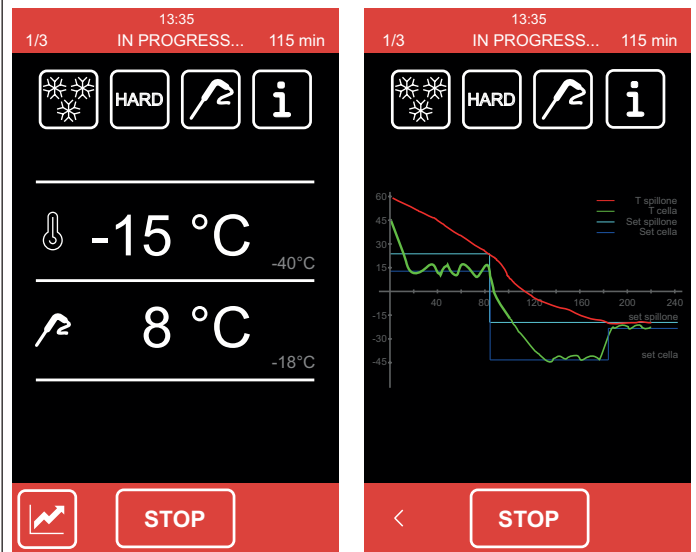

- Once the **BLAST CHILLING/SHOCK FREEZING** cycle has ended (either the core probe temperature has been reached or the time has ended), the buzzer rings and the **STORAGE** phase begins, after carrying out the DEFROSTING phase

- The **STORAGE** phase is endless and only ends if the  key is pushed

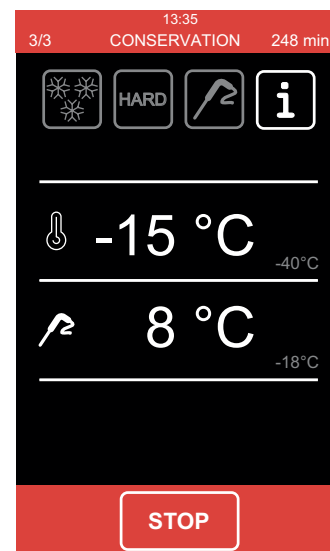

- COMBINED cycle with SLOW COOKING (MULTIFUNCTIONAL models)

- If available on the appliance, it is possible to add a **SLOW COOKING** or **SLOW COOKING + CONSERVATION** phase after blast chilling or shock freezing during the setting of a **MANUAL BLAST CHILLING/SHOCK FREEZING CYCLE**

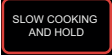
- In the lower part of the screen, two specific areas allow you to add a possible **SLOW COOKING**  phase or a **SLOW COOKING AND HOLD** phase 

If **SLOW COOKING** is selected at the end of the phase, the appliance will stop and remain in STAND-BY; if **SLOW COOKING + CONSERVATION** is selected at the end of the cycle, the appliance will continue operating with **CONSERVATION** phase and its adjustment preset. **CONSERVATION** phase is endless and only ends after pushing the STOP key for 5 seconds.



Presets for **SLOW COOKING** or slow **COOKING + CONSERVATION** are as per standard cycles.

SLOW COOKING = 80°C Chamber 60°C Core Probe
CONSERVATION: 60°C Chamber

It will be possible to adjust the value of each phase also during the setting of a manual cycle.



- Here below a setting as example:

HARD BLAST CHILLING + SLOW COOKING + CONSERVATION

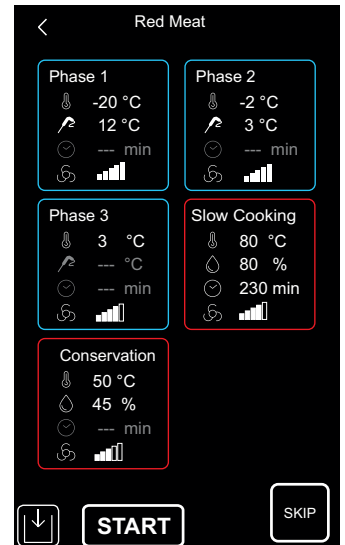
Push the **SKIP**  key to end the running phase and go to the next one



- HARD BLAST CHILLING/SHOCK FREEZING - SOFT BLAST CHILLING and STORAGE CYCLE

It is possible to select a hard blast chilling/ soft shock freezing by pushing  or  on the blast chilling /shock freezing setting screen. Before selecting this mode, make sure to set the type of desired cycle (**TIME-BASED** or **TEMPERATURE-BASED**).

This cycle is composed of two chilling phases with different setpoints and of a subsequent **STORAGE** phase.

- a first “hard” phase for blast chilling and “soft” for shock freezing, with unmodifiable setpoints defined by relative parameters;
- a second chilling phase **BLAST-CHILLING/SHOCK-FREEZING**
- a third **STORAGE** phase with adjustable setpoints.

At the end of a phase, the controller automatically starts next phase. The end of the first two phases is signalled by the buzzer ringing.

Also for this cycle it is possible to select the **TIME-BASED** mode: in this case, the passage to the next phases is determined by the elapsing of the set time.

- CONTINUOUS cycle





Push the key to select a **CONTINUOUS CYCLE**, to be started only by mode:

- TIME-BASED

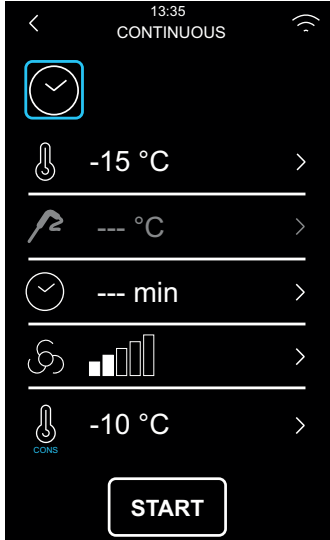

After selecting the cycle, a screen on which to set chamber temperature, fan speed, end-cycle storage duration and temperature values appears.

MULTITIMER



Cycle is started by pushing the  key; it ends only when all timers are elapsed; after this, the STORAGE phase begins

TIME-BASED cycle allows setting up to four **MULTITIMER** timers.

Cycle starts by activating only the first timer with its presets, while the other timers are activated by pushing the key    and setting a time while the cycle is already running.

When the timer is confirmed with time setting, the countdown starts directly.







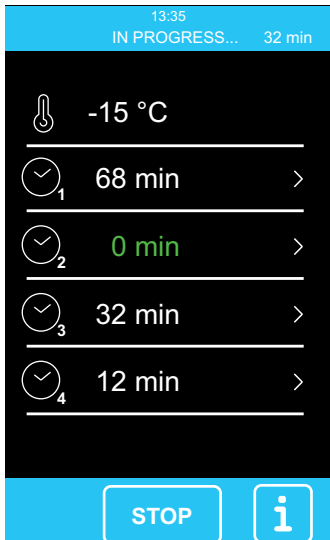



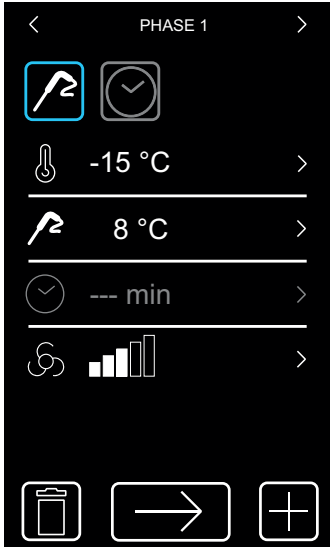









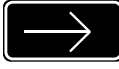
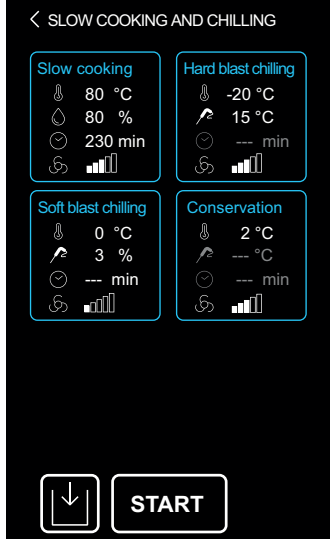







































Each timer is independent and, when elapsed, it can be reset and restarted.

Cycle ends only when all set timers are elapsed.

At the end of a timer countdown, the buzzer rings; a notification appears and the value “0 min” for the respective timer is visualized in green colour.



- CUSTOMIZED cycle

<p> MANUAL ></p> <p>- “MANUAL CUSTOMIZED” cycle allows setting a cycle composed of maximum 4 phases (3 CHILLING phases and 1 STORAGE phase), and can be composed of TEMPERATURE-BASED, TIMED-BASED or MIXED phases</p> <p>On MULTIFUNCTIONAL models it is possible to set a SLOW COOKING or SLOW COOKING + CONSERVATION phase at the end of the cycle</p>	 <p>PHASE 1</p> <ul style="list-style-type: none">  -15 °C >  8 °C >  --- min >  > <p>  </p>				
<p>- The “CUSTOMIZED” cycle is started by activating the first phase, which is a core-probe phase by default.</p> <p>It is possible to change the phase to TIME-BASED and set the relative setpoints.</p> <p>Push  to add any extra phase; push  to remove a phase from the program.</p> <p>Use the arrows on top to move among the various phases.</p> <p>Once the desired phases are entered and the various settings are carried out, push  to confirm: a summary screen will be then visualized.</p>	 <p>< SLOW COOKING AND CHILLING</p> <table border="1"> <tr> <td> <p>Slow cooking</p> <ul style="list-style-type: none">  80 °C  80 %  230 min  </td> <td> <p>Hard blast chilling</p> <ul style="list-style-type: none">  -20 °C  15 °C  --- min  </td> </tr> <tr> <td> <p>Soft blast chilling</p> <ul style="list-style-type: none">  0 °C  3 %  --- min  </td> <td> <p>Conservation</p> <ul style="list-style-type: none">  2 °C  --- °C  --- min  </td> </tr> </table> <p> </p>	<p>Slow cooking</p> <ul style="list-style-type: none">  80 °C  80 %  230 min  	<p>Hard blast chilling</p> <ul style="list-style-type: none">  -20 °C  15 °C  --- min  	<p>Soft blast chilling</p> <ul style="list-style-type: none">  0 °C  3 %  --- min  	<p>Conservation</p> <ul style="list-style-type: none">  2 °C  --- °C  --- min 
<p>Slow cooking</p> <ul style="list-style-type: none">  80 °C  80 %  230 min  	<p>Hard blast chilling</p> <ul style="list-style-type: none">  -20 °C  15 °C  --- min  				
<p>Soft blast chilling</p> <ul style="list-style-type: none">  0 °C  3 %  --- min  	<p>Conservation</p> <ul style="list-style-type: none">  2 °C  --- °C  --- min  				

Push  to start the cycle or  to save it into the recipe list.

9.4 SETPOINT setting

9.4.1 CHAMBER TEMPERATURE SETPOINT setting

When a blast-chilling, shock-freezing, continuous or customized cycle is selected, the chamber temperature, product temperature, time and fan speed presets are loaded as per parameter settings. These values can be adjusted by users withing the defined ranges.

Push the  key next to the value to adjust to enable the adjustment; the screen here below will appear and the value to be adjusted will turn different color.



- Set the desired value using the lower bar

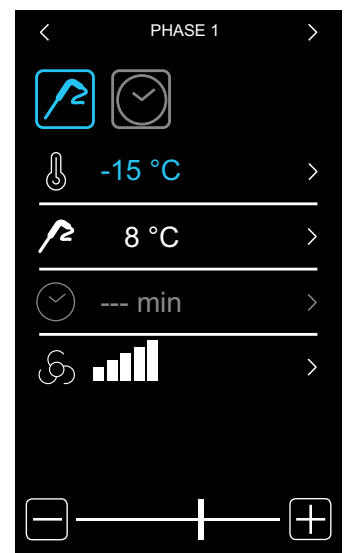

Once the setting is completed, push the  key next to the adjusted value and return to the previous screen.



9.4.2 PRODUCT TEMPERATURE SETPOINT setting

Proceed as described for chamber setpoint, after pushing the  key regarding product temperature (i.e. the temperature detected by core probe) .

9.4.3 CYCLE DURATION setting

Proceed as described for chamber setpoint, after pushing the  key regarding cycle duration.

9.4.4 FAN SPEED setting

Proceed as described for chamber setpoint, after pushing the  key regarding fan speed. Minimum fan speed can be set for any cycle except **SLOW COOKING**.

9.5 CYCLE execution

- Push the  key to start a cycle as per settings.

If the cycle is **TEMPERATURE-BASED**, blast-chilling/shock-freezing phases end when the core probe (or core probes) reach the set temperature. If the cycle is **TIME-BASED**, blast-chilling/shock freezing phases end when the set time(s) elapse.

The following screen is displayed during the execution of the cycle.

Push the  key to visualize probe values, input/output status and possible running alarms.



9.6 CYCLE end

- If the **TEMPERATURE-BASED** blast-chilling/shock-freezing cycle ends correctly, i.e. temperature at product core is reached within the allowed time, STORAGE phase automatically starts and the following screen is displayed.

if the **TEMPERATURE-BASED** cycle does not end within the allowed times, the alarm icon will warn about the anomaly, but the chilling cycle will continue anyway.



- For **TEMPERATURE-BASED** cycles, push the  key to display the screen allowing the functions of:

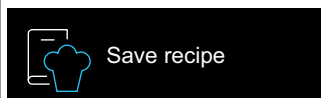

- memorization of the previously carried-out cycle.
- or push the STOP key again to return to main menu

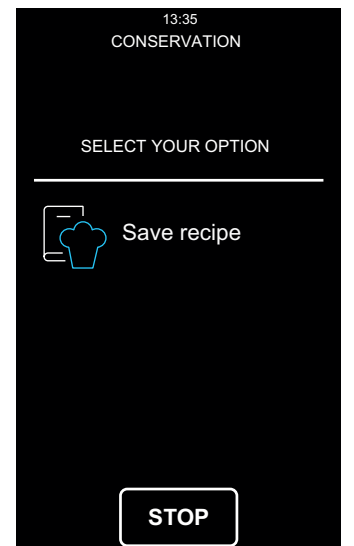

- At the end of a **TIME-BASED** cycle, the blast-chilling/shock-freezing mode starting screen will be displayed.

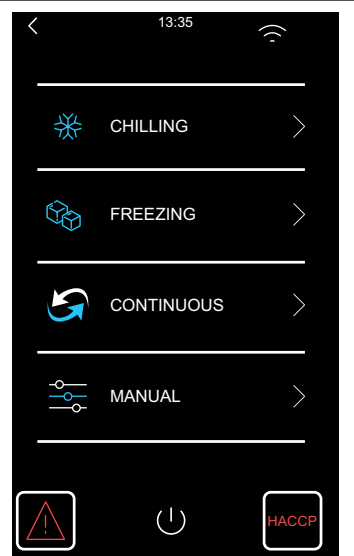

9.7 SPECIAL and MULTIFUNCTIONAL cycles

 SPECIAL CYCLES >

Push the **SPECIAL CYCLES** key on the **HOME** screen to open the following screen with the following **SPECIAL CYCLES**:

- manual defrosting
- ice-cream hardening
- drying
- sanification
- chocolate
- sterilisation (optional)
- thawing (MULTIFUNCTIONAL model thawing optional)
- retarding-proofing (MULTIFUNCTIONAL model)
- slow cooking (MULTIFUNCTIONAL model)

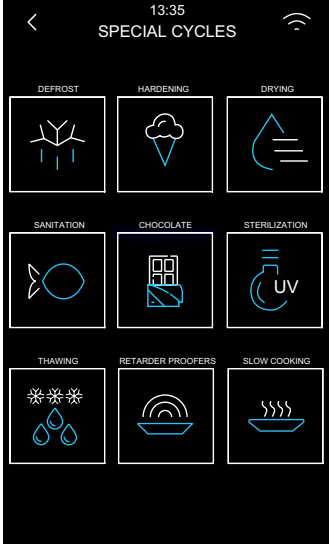

9.7.1 SANIFICATION cycle



Push the key to select a **SANIFICATION** cycle.
It is a special cycle composed of the following phases with this preset:

CHILLING | CONSERVATION | STORAGE

< CHILLING >

SANIFICATION

🌡️ -40 °C >

📈 -20 °C >

🕒 --- h >

🔄  >

START

< HOLDING >

SANIFICATION

🌡️ -20 °C >

📈 -20 °C >

🕒 24 hour >

🔄  >

START

< CONSERVATION >

SANIFICATION

🌡️ -20 °C >

📈 --- °C >

🕒 --- h >

🔄  >

START

The arrows on top allows moving among the various phases for the sanification to visualize/adjust setpoints. After selecting the function, a screen containing the presets is displayed, which can be adjusted.

Push the  key to start the sanification. Chilling end temperature, operation setpoint during chilling and conservation duration are displayed during the execution of a sanification.

The **SANIFICATION** cycle starts with a **CHILLING** phase. When the temperature detected by the core probe reaches the chilling end temperature, the appliance will start **CONSERVATION**.

Chilling end temperature is also the operation temperature during conservation.

After the time set for conservation has elapsed, **STORAGE** automatically starts.

Core probe insertion test is always carried out at the beginning of the cycle: if the test is not passed, the buzzer rings and the cycle is interrupted.

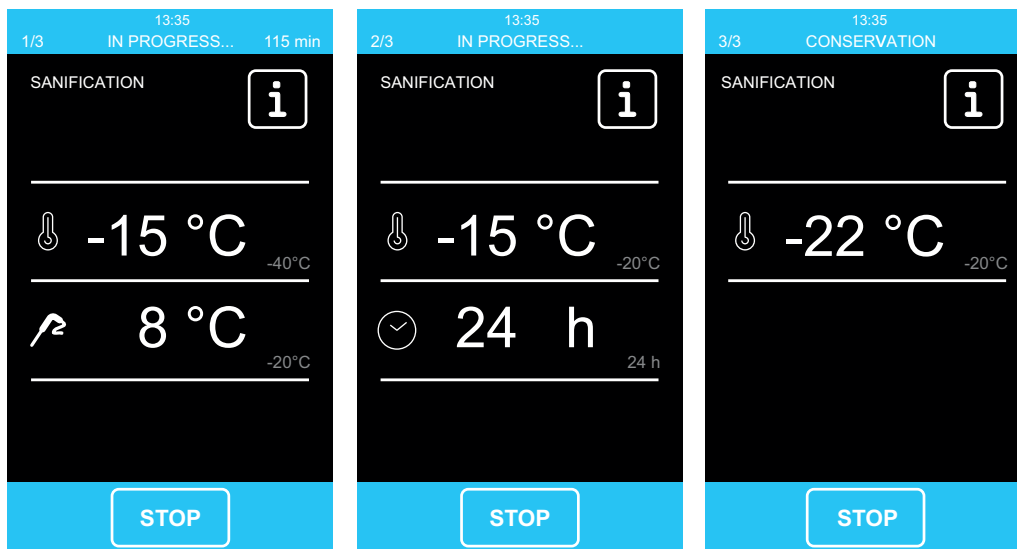

During chilling, the appliance displays the temperature detected by the core probe, the chamber temperature and the time elapsed since chilling has started.

The cycle can be interrupted ahead of time by pushing the  key

9.7.2 THAWING cycle (optional)



Push the key to select a **THAWING** cycle, managed according to the loaded quantity of product to be thawed as compared to the maximum quantity declared by the producer.

For **MULTIFUNCTIONAL** models, it is possible to select **SLOW COOKING** or **SLOW COOKING WITH CONSERVATION** at the end of **THAWING**

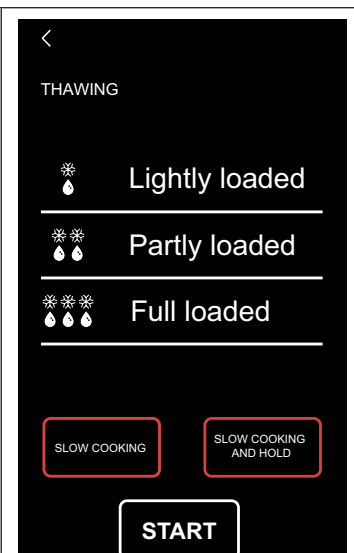

At the end of the **THAWING** cycle, the buzzer rings and **STORAGE** starts with endless duration.

Defrosting cycles are inhibited during thawing, while it is possible to carry out an automatic defrosting (with parameter-based intervals) during storage.

In case the door is opened, the appliance is blocked. Here below the screen displayed during a running thawing.

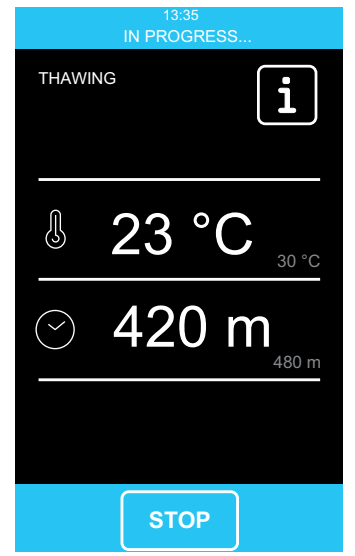

9.7.3 MANUAL DEFROSTING cycle



Push the key to select a **MANUAL DEFROSTING** cycle, to be started by pushing the **START** key.

After starting the cycle, the following screen is displayed.

NOTE: Defrosting is also carried out automatically with defined time intervals and it is activated only if necessary

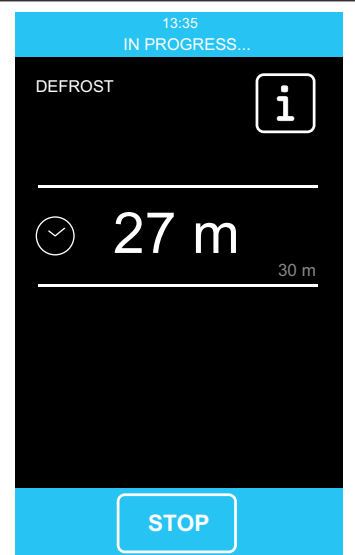

9.7.4 ICE-CREAM HARDENING cycle



Push the key to select an ice-cream hardening cycle.

It is a **TIMED-BASED SHOCK FREEZING**. When the time is over, no storage is started: the hardening cycle continues until the **STOP** key is pushed.

Opening the door stops the countdown, which will resume after closing the door.

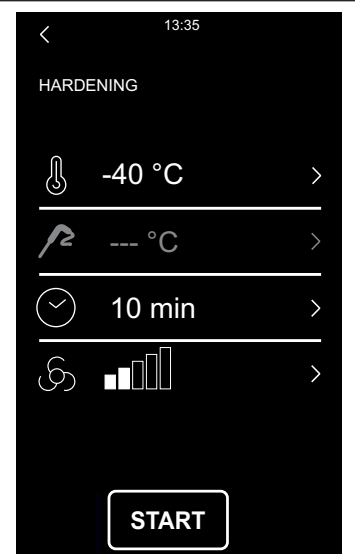

9.7.5 CHAMBER STERILISATION cycle (Optional)



Push the key to select a **STERILISATION** cycle.

Push the **START** key to start the sterilisation cycle. The time countdown will be displayed. Sterilisation ends when time is over, when the key **STOP** is pushed or when the door is opened.

At the end of the cycle, the buzzer rings and the display returns to the **HOME** screen.

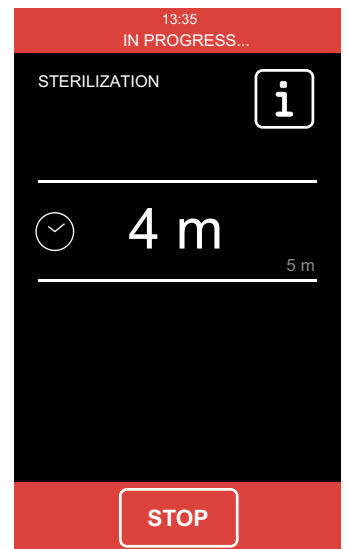
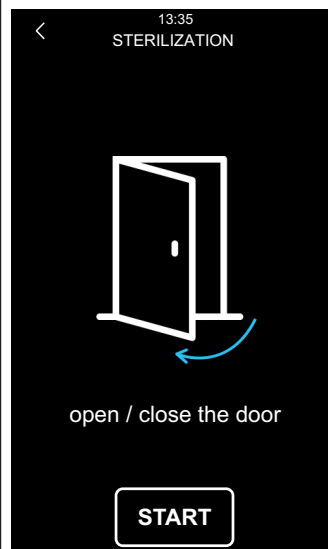

9.7.6 CHOCOLATE cycle



Push the key to select a **CHOCOLATE** cycle. Push the **START** key to start **TIME-BASED** (30 min.) **CHOCOLATE CHILLING** cycle, with chamber temperature 8°C and low fan speed. At the end of the Time, **STORAGE** with chamber temperature 14°C is started.

The cycle stops when time elapses or by pushing the **STOP** key.

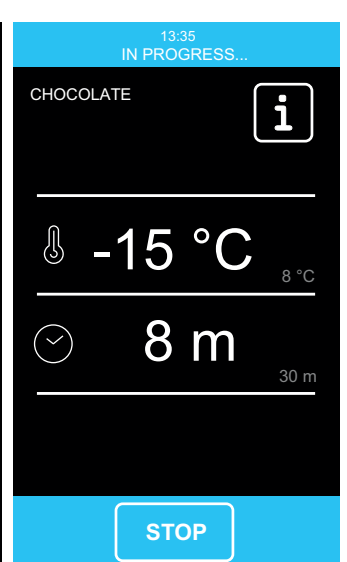
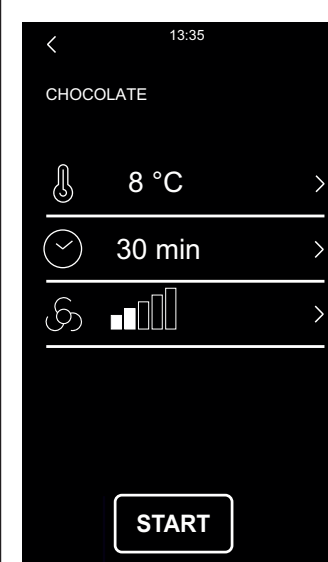

9.7.7 DRYING cycle



Push the key to select a **DRYING** cycle.

It is a forced ventilation cycle without chilling to dry the internal chamber. After starting it is advisable to keep the door open during the execution of the cycle.

The cycle stops when the time is over or by pushing the **STOP** key.

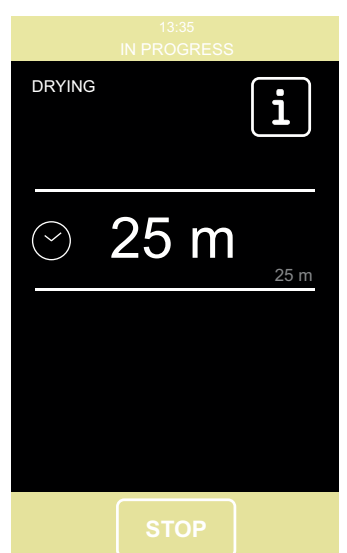

9.7.8 RETARDING-PROOFING cycle (MULTIFUNCTIONAL models)



Push this area to select a complete **RETARDING-PROOFING** cycle for pastry and bakery, so as to automatically manage the complete retarding-proofing cycle of the dough.

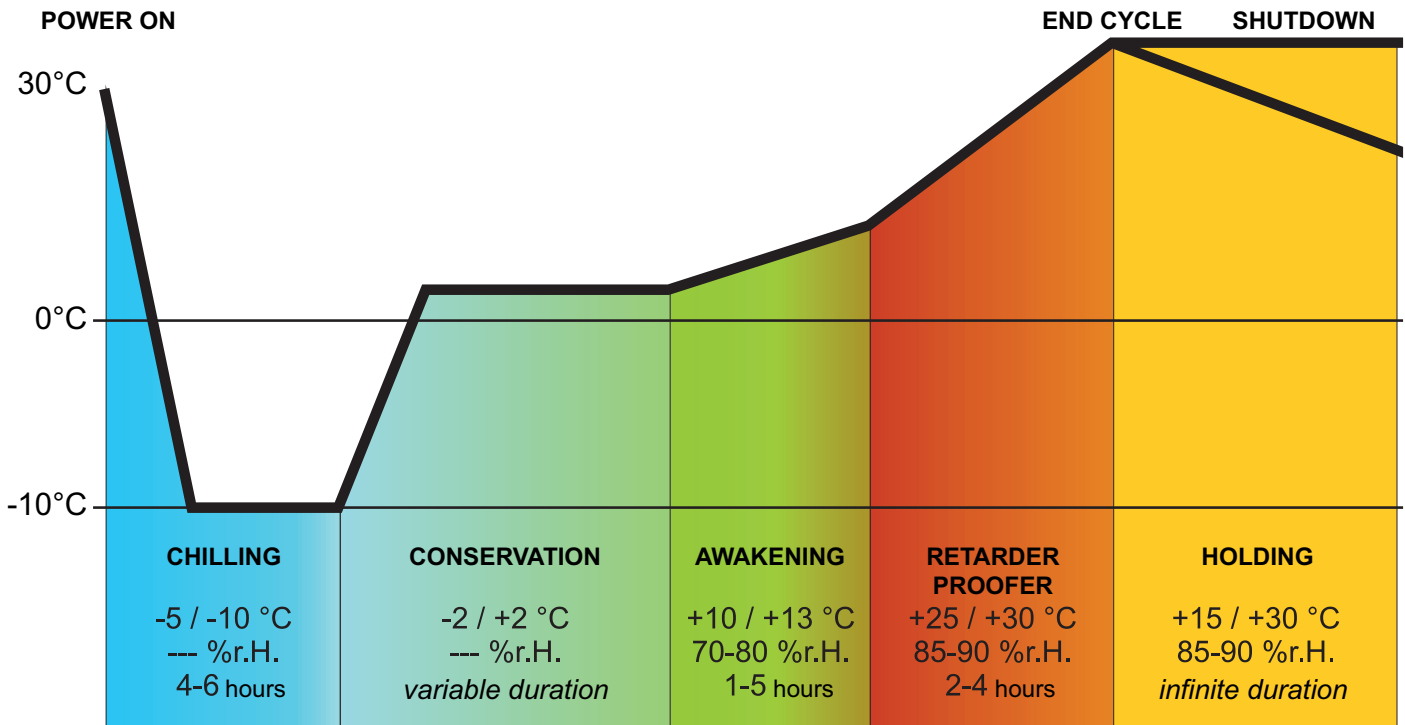

An automatic retarding-proofing cycle is composed of 5 different phases with different temperatures, relative humidities, fan speeds and durations. All these phases are automatically carried out one after the other, as per following details:

BLOCK phase

Temperature adjustment is active and by neutral zone; temperature, fan speed and phase duration in hours and minutes are determined by end users. No humidity control is foreseen in this phase.

STORAGE phase

Temperature adjustment is active and by neutral zone; temperature and fan speed are determined by end users. No humidity control is foreseen in this phase. The passage from block temperature (previous phase) to storage temperature can be gradual. The duration of this phase is automatically calculated by the appliance based on the durations of block, proofing and leavening phases and on the desired end date and time of dough leavening.

PROOFING phase

Temperature adjustment is active and it is NEUTRAL ZONE; operation temperature is determined by end users. The passage from storage temperature (previous phase) to proofing temperature can be gradual.

Relative humidity adjustment is active and it is NEUTRAL ZONE; humidity is determined by end users. Phase duration in hours and minutes and evaporator fan speed are determined by end users.

LEAVENING phase

Temperature adjustment is active and it is NEUTRAL ZONE; temperature is determined by end users. The passage from proofing temperature (previous phase) to leavening temperature can be gradual. Relative humidity adjustment is active and it is NEUTRAL ZONE; humidity is determined by end users.

Phase duration in hours and minutes and evaporator fan speed are determined by end users.

DELAY phase (Conservation)

Delay phase is always activated, but it can be deactivated (both at cycle setting and with running cycle) by end users. In this case the appliance will be in STAND-BY at the end of leavening. Temperature adjustment is active and it is NEUTRAL ZONE; temperature is determined by end users.

Relative humidity adjustment is active and it is NEUTRAL ZONE; end users can determine both humidity and evaporator fan speed.

Phase duration is either adjustable in time or endless, i.e. it ends when cycle is interrupted by pushing the  key.

9.7.9 PRETARDING-PROOFING CYCLE setting

- Cycle start and stop



Push the key to access the following screen, displaying the phases of a **RETARDING-PROOFING** cycle:

- Block
- Storage
- Proofing
- Leavening
- Delay

Cycle is started by pushing on the  key and it ends automatically at the end of phase 4 and according to the set end time, with an acoustic signal.



In case set end time is later than the sum of each phase time, the controller will automatically increase storage time (phase 2) to fill in the time gap.

Manual interruption can be carried out in any phase by pushing the key  for 4 seconds.

Note: phase 5 (delay) is optional and does not include duration settings; therefore, if activated, it will end automatically after the set duration, which can also be endless, is elapsed. In this case, it can only be ended by pushing the  key.

- If phase 5 is not activated, the cycle ends and the STAND-BY screen is displayed

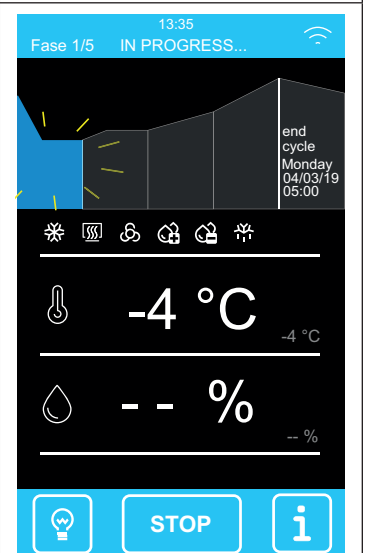

- Cycle phase adjustment

Before starting a cycle, it is possible to access the setpoint setting menu for each retarding-proofing phase by pushing on the central area corresponding to the phase to be adjusted. Push the **<** **>** keys to go from a phase to the next.

Prest values for each phase (as per following chart) are loaded by default. Cycle sets can be adjusted before starting by using the dedicated menus; once the **START** key is pushed, the retarding-proofing cycle is started.

It is possible to adjust temperature, humidity, fan speed values of the running phase during the execution of the cycle.

If a phase is set with duration "0", it will not be carried out.

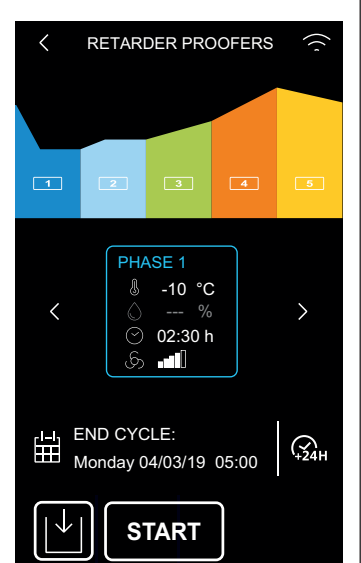

CHILLING	Chamber Set	5°C
	Humidity Set	---
	Duration Set	2 h
	Ventilation Set	5
PROOFING	Chamber Set	20°C
	Humidity Set	60 %rH
	Duration Set	3 h
	Ventilation Set	5
LEAVENING	Chamber Set	30°C
	Humidity Set	80 %rH
	Duration Set	180 min
	Ventilation Set	5
STORAGE	Chamber Set	25°C
	Humidity Set	80 %rH
	Phase activation	"yes" (activated), "no" (deactivated)
	Ventilation Set	5

- Cycle end date and time adjustment

Icon  **CYCLE END** is visualized bottom left with indication of cycle end set time; the indicated date and weekday are calculated automatically according to the sum of set times for each phase (from phase 1 to phase 4).

Push on **CYCLE END** area to access cycle end time adjustment; only after confirming it, it will be possible to adjust cycle end date, which can only be postponed to the first automatically calculated available date.

As an alternative, cycle end date can be postponed of 24 hours by using hot key .

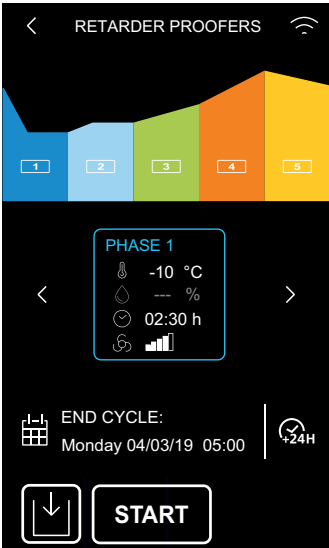
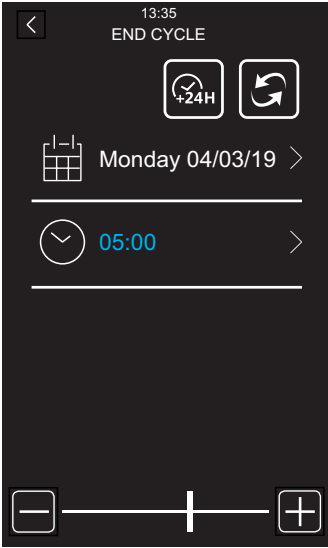
9.7.10 SLOW COOKING CYCLE setting (MULTIFUNCTIONAL Models)

Icon  Push the key to select a **SLOW COOKING** cycle. A screen will be displayed, where it will be possible to visualize and adjust relative values and decide whether to set a **TEMPERATURE-BASED** or a **TIME-BASED** cycle; it is not possible to adjust the valued during cycle execution.

The appliance will be in **STAND-BY** at the end of the cycle.

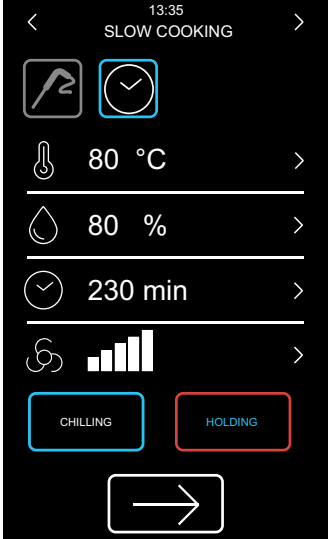

Two specific areas located in the lower part of the screen allow adding an extra phase:

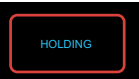
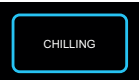
-  **CONSERVATION/STORAGE**
-  **BLAST CHILLING/SHOCK FREEZING**

If **CONSERVATION** will be activated at the end of a **SLOW COOKING** cycle, it will operate with the set temperatures and humidity and it will have an endless duration.

If **BLAST CHILLING** or **SHOCK FREEZING** are activated, they will be carried out according to their specific modes (blast chilling/shock freezing with storage automatically following)



9.8 RECIPES

The following preset recipe types are available: **BLAST-CHILLING RECIPES | SHOCK-FREEZING RECIPES**. Preset values can be temporarily adjusted, but the recipe can only be saved in “**MY RECIPES**” recipe list.

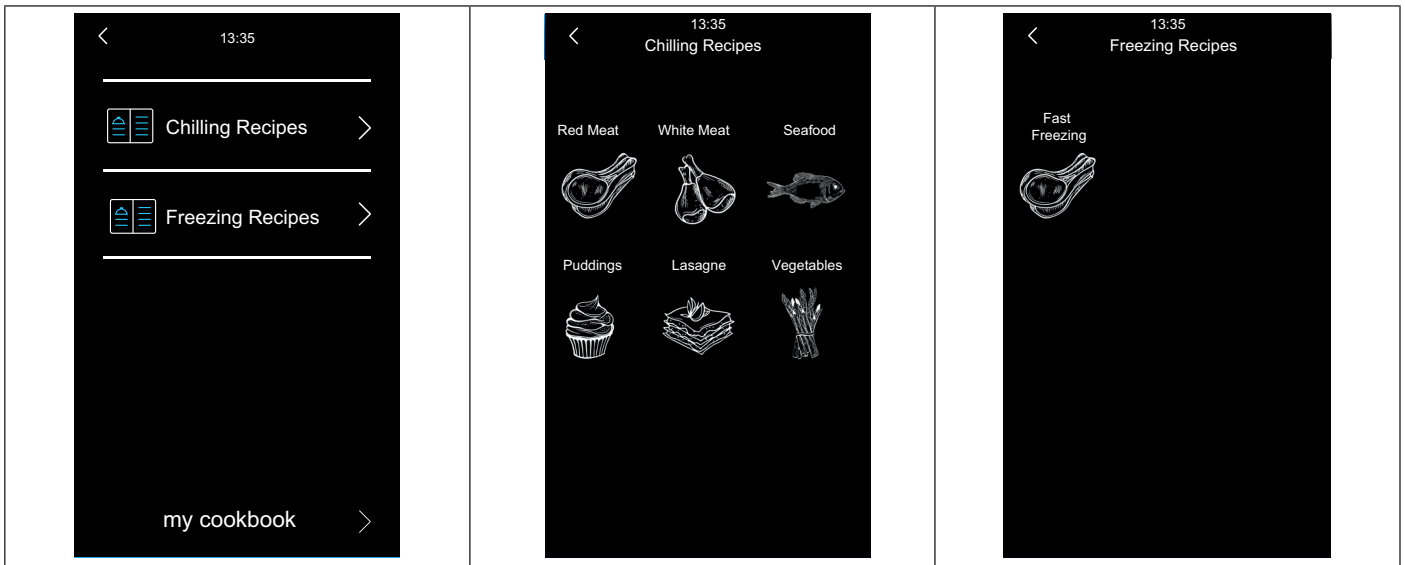

- “MY RECIPES”

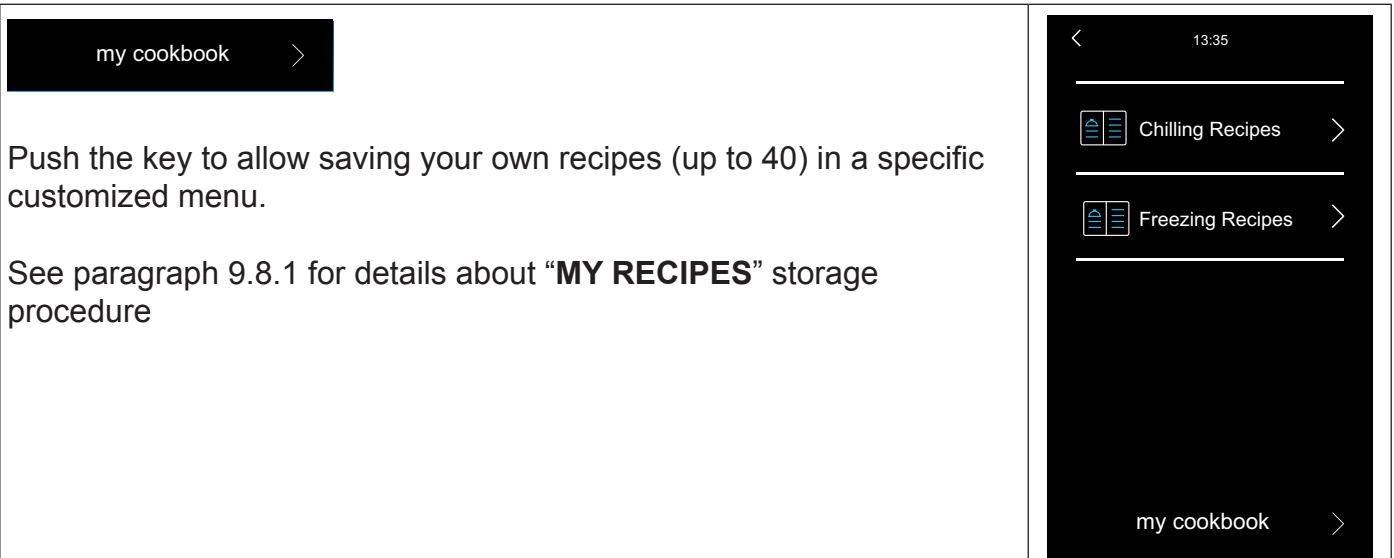

Push the key to allow saving your own recipes (up to 40) in a specific customized menu.

See paragraph 9.8.1 for details about “**MY RECIPES**” storage procedure

9.8.1 “MY RECIPES” storage

It is possible to store both **TIME-BASED** and **TEMPERATURE-BASED** cycles.

The following storage modes are available:

- **Before carrying out the cycle:** by selecting an existing recipe, adjusting it, then save it.
- **During storage:** after a CUSTOMIZED BLAST-CHILLING/SHOCK-FREEZING cycle, when the  key is pushed, the appliance will suggest storing the carried-out recipe.

In case a **TEMPERATURE-BASED CYCLE** is stored, what will be stored is the time needed to reach the desired temperature at product core.

Here below an example of how to “**SAVE A RECIPE**” before carrying out the cycle.

After setting the desired cycle, set the appliance in “Cycle Summary” status.

Before pushing the , key, store the recipe as follows:

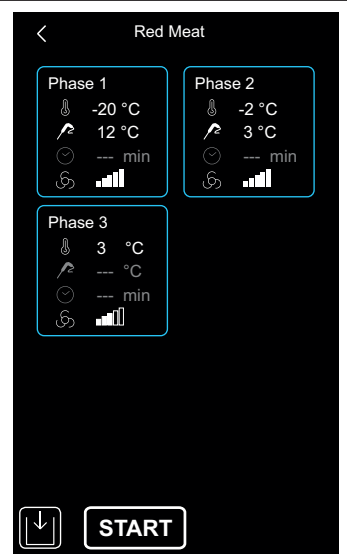

- Push the  key

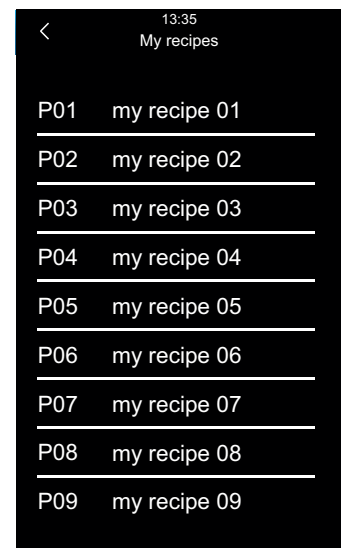

Access “**MY RECIPES**” page, showing a list with available positions (indicated with “---”) and the possibly previously saved recipes.



- Scroll and select the position in which to save the new recipe or overwrite an existing one

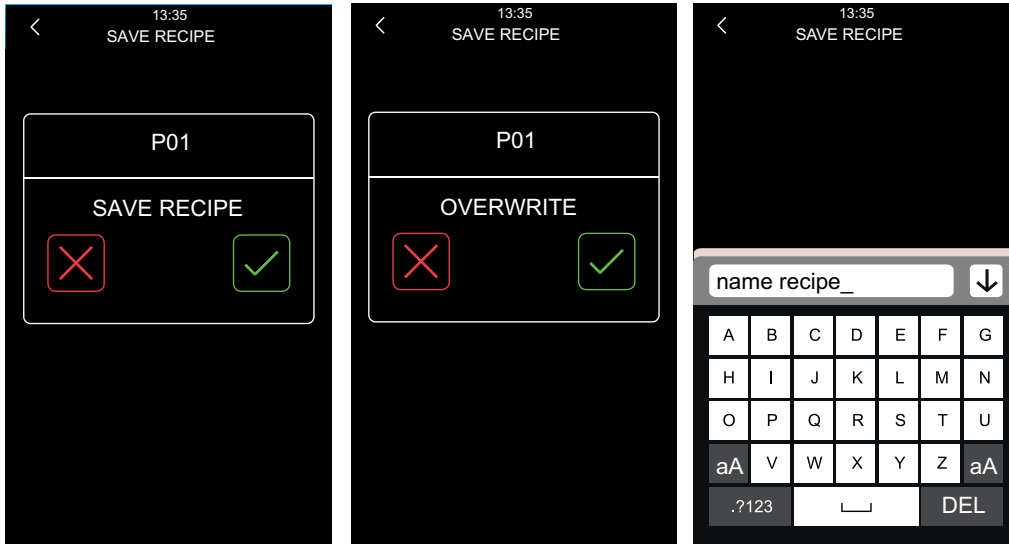

- Push the  key to confirm and access the alphabetical keyboard (push the  key to exit without saving)

- Type in the desired recipe name and push to confirm



Proceed as follows if you wish to change the recipe name:

- Push on the name of the desired recipe

- Push the  key to confirm overwriting and access the alphabetical keyboard (push the  key to exit without saving)

- Cancel the displayed recipe name with the  key and type in the new recipe name

- Push the  key to confirm.

9.8.2 “MY RECIPES” recipe start

Operate as follows to start a recipe:

- Make sure the appliance is on and no procedure is running;

- Push the  key

- Enter the  menu and select the desired recipe

- Push the  key on the “cycle summary” page to start the recipe



- In case you wish to adjust recipe data, push   to adjust presets.

9.8.3 “MY RECIPES” recipe removal

Operate as follows to remove a recipe:

Select the recipe you wish to remove from “MY RECIPES” list and push the  key of PHASE 1 within 5 seconds.

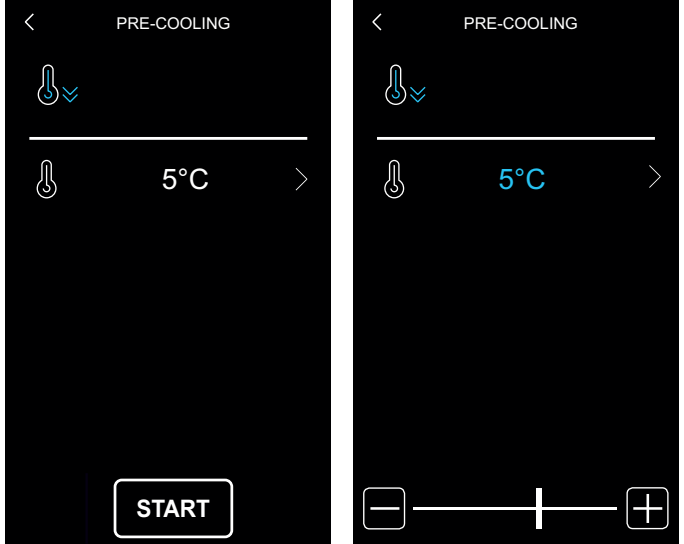
9.9 PRECOOLING cycle

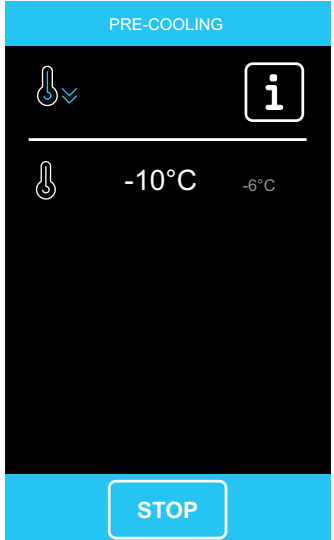
<p> PRE-COOLING ></p> <p>Push the key on the HOME screen to start a PRECOOLING cycle.</p> <p>It is similar to standard blast chilling and it can be activated before any cycle.</p> <p>The following screen is displayed when the sensitive area is pushed.</p>	
<p>Set the desired temperature value and push the  key to start chamber PRECOOLING.</p> <p>The following screen will be displayed, where the execution of precooling is highlighted.</p> <p>Push the  key to stop PRECOOLING.</p>	

Once the desired temperature is reached, the buzzer rings and the cycle continues by keeping the reached chamber temperature until the  key.

At the end of the cycle, the **HOME** page will automatically be displayed.

9.10 HACCP Alarms

If there have been any alarms to access the alarm area push the  key on the **HOME** screen to access the HACCP alarm area.

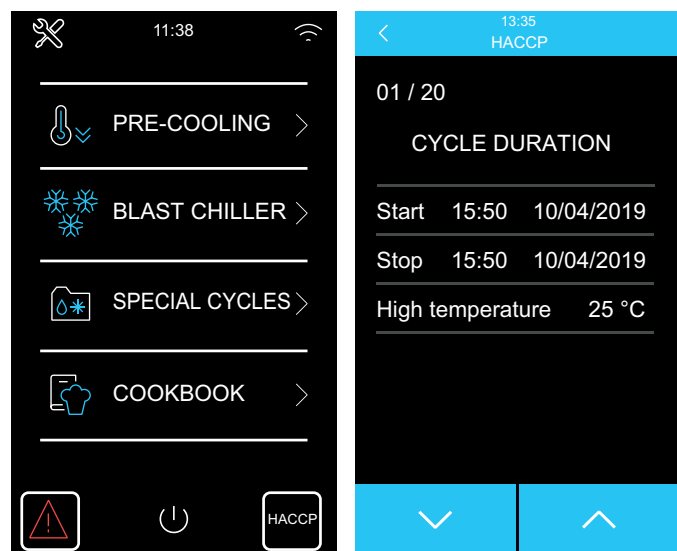

The alarms of the HACCP list are:

- Blast chilling/shock freezing cycle duration
- Power failure
- Open door
- High temperature alarm
- Low temperature alarm



9.11 HACCP alarm archive visualization

With the “HACCP” function it is possible to store up to 20 events, after which the more recent

event overwrites the oldest. Access HACCP alarm area and push the   keys to visualize all alarms.

9.12 Other alarms

By pressing the “danger”  key, any active alarms “ON” are displayed



ALARM	DESCRIPTION	CAUSE	SOLUTION
RTC	Internal clock alarm	Lack of calibration	Set the clock
CHAMBER PROBE	Chamber probe failure alarm	Faulty chamber probe	Replace probe
EVAPORATOR PROBE	Evaporator probe failure alarm	Faulty evaporator probe	Replace probe
CONDENSER PROBE	Condenser probe failure alarm	Faulty condenser probe	Replace probe
CORE PROBE	Core probe failure alarm	Faulty core probe	Replace probe
HIGH PRESSURE	Refrigerating unit gas pressure has exceeded the maximum safety limit	- Dust-clogged condenser - Idle condenser fan	- Clean the condenser - Check the condenser fan
LOW PRESSURE	Refrigerating unit gas pressure is lower than the minimum operation limit	- Closed liquid electrovalve - Faulty thermostatic valve - Gas leak	-Service -Service -Service
OPEN DOOR	Open door alarm	The door has remained open beyond the maximum set time	- Close the door - Check door microswitch
HIGH CHAMBER TEMPERATURE	High chamber temperature	Chamber temperature has exceeded the maximum set value	- Check refrigerating unit - Service
LOW CHAMBER TEMPERATURE	Low chamber temperature	Evaporator temperature is lower than the minimum set value	- Check refrigerating unit - Service

ENGLISH

HIGH EVAPORATOR TEMP.	High evaporator temperature	Evaporator temperature has exceeded the maximum set value	- Check internal fans - Service
CYCLE DURATION	Blast chilling or shock freezing were not ended within their maximum duration	Product has not reached the minimum set temperature within the set times for automatic blast-chilling or shock-freezing cycle	- Check internal fans - Check product size - Service
BASE COMMUNICATION	Communication error between user interface and control module	Communication problems between interface and control module	- Check interface - control module connection - Service
POWER FAILURE	Power failure alarm	Power interruption alarm	Check electrical connection
SANIFICATION CORE PROBE INSERTION	Sanification alarm	Sanification cycle has been stopped for core probe insertion alarm	- Check the correct insertion of probe into product
SANIFICATION DURATION	Sanification cycle alarm	Sanification has not ended because set temperature was not reached	- Check core probe insertion - Check product quantity
OVERHEATED CONDENSER	High condenser temperature alarm	Condenser temperature has exceeded maximum value for good operation	- Clean the condenser - Check condenser fan
BLOCKED COMPRESSOR	Condenser temperature safety alarm	Condenser temperature has exceeded the safety value	- Clean the condenser - Check condenser fan
CORE PROBE INSERTION	Alarm for not inserted probe	Probe has not been inserted into product and the selected program requires it	- Check the correct insertion of probe
EXPANSION COMMUNICATION	Communication error between user interface and expansion module	Communication problems between interface and expansion module	Service

It is possible to set the following on the INFORMATION page:

- **TIME AND DATE:** allows setting time and date for the day
- **SERVICE / INTERNAL DATA:** these areas are intended for authorized technical personnel
- **LANGUAGE SELECTION:** it is possible to set/change the control panel language

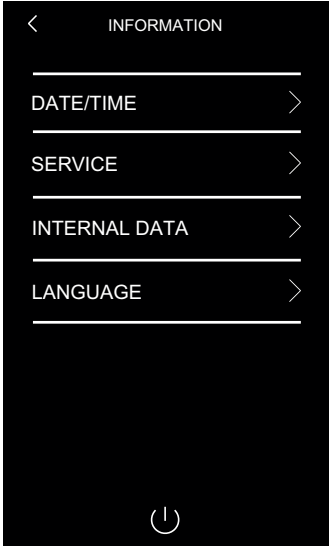
<p>Push the  key top left on the HOME screen to access INFORMATION area.</p> <p>The page displays the following menus:</p> <ul style="list-style-type: none"> - DATE/TIME - SERVICE (PARAMETERS) - INTERNAL DATA - LANGUAGE 		
--	--	---

10.1 DATE/TIME setting

Allows adjusting time and date of the appliance; it is also possible to set the hour format 12h / 24h - a.m / p.m. and the date format dd/mm/yyyy - mm/dd/yyyy

10.2 - SERVICE (PARAMETERS)

Intended for authorised technical personnel (Chapter 17)

10.3 INTERNAL DATA

The list of the available functions is displayed:

- alarms;
- input and output status;
- compressor operation hours;
- HACCP data selection;
- internal data reset.

“Internal data reset” menu, accessible by password (password: 99) allows resetting the following data:

- compressor operation hours;
- HACCP alarms
- user’s recipe

10.4 LANGUAGE

From this area it is possible to set the language among the available ones.

CHAPTER 11 NOISE LEVEL

The blast chiller is designed and constructed so that risks resulting from the emission of airborne noise are reduced to the minimum level (see technical information).

CHAPTER 12 MATERIALS AND FLUIDS USED

The materials in contact or which may come into contact with foodstuffs comply with the relevant directives. The blast chiller has been designed and built in such a way that these materials can be cleaned before each use.

Refrigerating fluids R452A comply with new EU regulation 517/2044 F-Gas.

R452A is a fluorinated gas, with GWP potential of 2141



The symbol indicates that this product must not be treated as household waste.

To prevent potential negative consequences for the environment and human health, make sure that this product is properly disposed of and recycled.

For more information regarding the disposal and recycling of this product, please contact your Distributor, after sale Service, or waste treatment Service.



CHAPTER 13 TRANSPORT AND HANDLING



The transport and handling of the blast chiller must only be done while maintaining the vertical position, observing the markings on the packaging.

The manufacturer disclaims any liability for problems resulting from transport performed under conditions other than those specified above.

The accessories of the blast chiller (guides, grilles, trays) are packaged separately and placed inside the unit.

PROFESSIONAL TRAY blast chillers are fixed on a wooden base and protected by accidental impacts by polyethylene, cardboard, crate or wooden box packing.

The blast chiller is mounted on a wooden base and protected from accidental impact with polyethylene, carton, crate or boxes.

Regarding the disposal of the packaging it is necessary to refer to current regulations in your country.



The movement of the blast chiller shall be performed using a fork lift or pallet trucks equipped with suitable forks (length of at least 2/3 of the unit).

The dimensions and masses of the refrigerated cabinets packed are shown in Table 1.

The limits of stackability and the centre of gravity are indicated on the label of the package.

13.1 Positioning operations

Since the incorrect positioning of the blast chiller can cause damage to the same, jeopardizing its proper functioning and result in risk to the personnel, the installer must adhere to the following general rules:

- keeping a minimum distance of 3 cm from any wall and 50 cm from ceiling
- the environment must be sufficiently ventilated
- position the blast chiller away from heat sources
- do not install outdoors without suitable protective covering
- avoid exposure to direct sunlight
- remove the polyethylene, cardboard or wood packaging



Polyethylene is dangerous for children

- remove any accessories with external connections

Removing the wooden base (Fig.4): lift the blast chiller and remove the base.

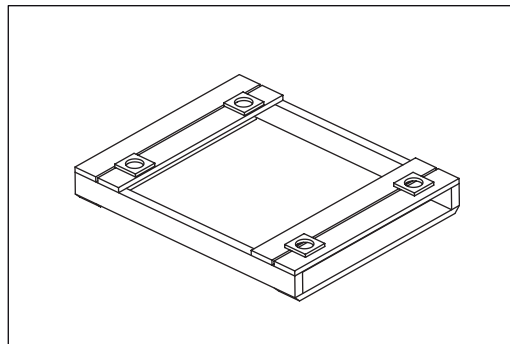

Fig.4



use protective gloves when handling the wooden packaging and the wooden base.

The presence of splinters may cause damage to your hands

- remove the PVC film applied as a protection to the outer surfaces of the blast chiller
- position the blast chiller using a level with possible adjustment models PROFESSIONAL TRAY of the feet of the metal base (Fig. 5)

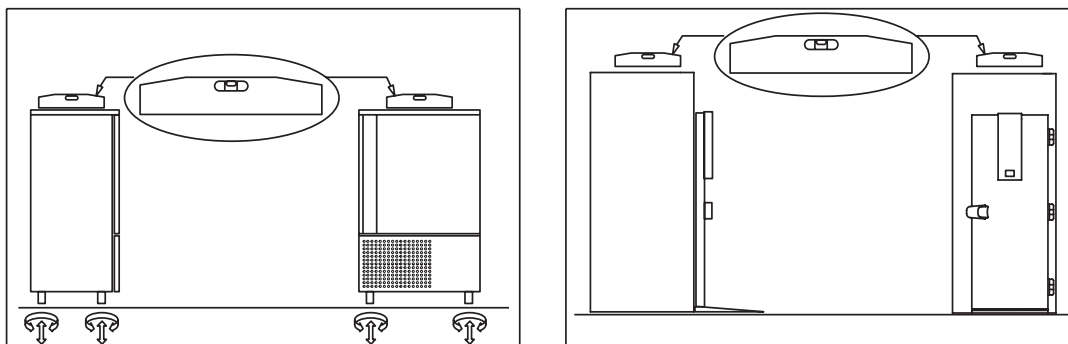

Fig.5

- For TRAY models, place slide-way supports (Picture 6) into the specific rack holes

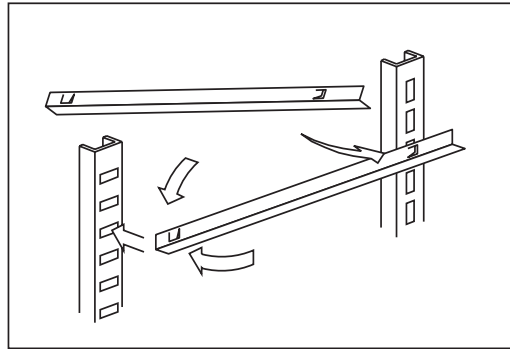

Fig.6

- insert the grilles for food in the special guides
- insert the condensate water drain pan into the special guide rails already fixed under the blast chiller if provided.

13.2 REM Blast chillers (Fig. 7)

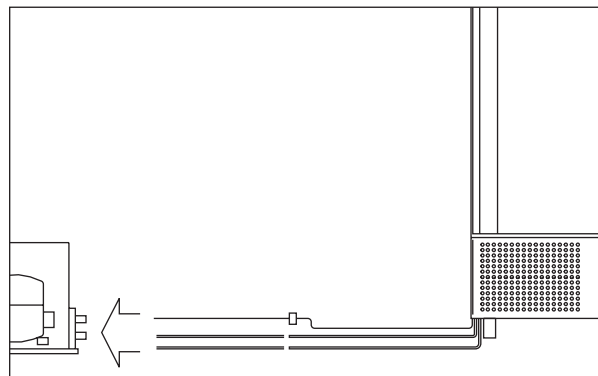

Fig.7

- position the blast chiller as described above (Fig. 5)
- N.B.: the unit is supplied with Nitrogen pressure from the factory
- prepare the two pipes that protrude from the temperature blast chiller for the connection to the respective pipes
 - connect the pipes of the condensing unit to the pipes of the blast chiller
 - create a vacuum and then carry out the loading of the refrigerant
 - make the electrical connection of the blast chiller to the condensing unit

CHAPTER 14 ELECTRICAL WIRING AND CONNECTIONS

The electrical system and connection must be carried out by qualified personnel. Before installation, measure the impedance of the network, the impedance value for the connection to the network must not exceed 0.075 ohm.

For safety reasons you must follow these guidelines:

- verify that the sizing of the electrical system is suitable for the power consumption of the blast chiller and that it provides for a differential switch (circuit breaker)
- All the chillers are supplied to no electrical plug (Figure 8), for connection to carefully observe what described on the label on the electrical connection cable (5)
- In case the socket is not compatible with the condensing unit plug, replace the plug with a suitable one, provided it is compliant with legal standards.

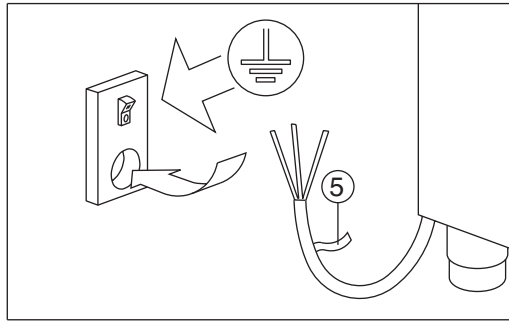

Fig.8



The power cord has the connection type “Y” and it can be replaced exclusively by the manufacturer or authorized technical service



It is essential to correctly connect the blast chiller to an efficient earthing system carried out as specified by the applicable provisions of law.

CHAPTER 15 INSTALLATION OPERATIONS

It is important, in order to prevent errors and accidents, to perform a series of checks before starting up the blast chiller in order to identify any damage incurred during transport, handling and connection.

Checks to be performed:

- check the integrity of the power cord (it must not have suffered abrasions or cuts)
- check the solidity of the legs, door hinges, shelf supports
- check the integrity of the internal and external parts (pipes, heating elements, fans, electrical components, etc.) and their fixing
- check that the seals of the doors have not been damaged (cuts or abrasions) and close with an airtight seal
- check the integrity of the pipes and fittings

CHAPTER 16 REINSTALLATION

It is necessary to comply with the following procedure:

- disconnect the power cord from the power outlet
- the handling should be carried out as described in chapter 13
- for a new placement and connection, please refer to par. 13
- proceed to the possible recovery of the refrigerant gas in accordance with the regulations in force in your country



WARNING!

**INSTRUCTIONS STRICTLY RESERVED TO AUTHORIZED
TECHNICAL PERSONNEL**

Every intervention executed by a non authorized technical personnel
implies a warranty decay.

It is possible to access **INTERNAL DATA** modification screen from the **INFORMATION** page

Push the  ket top left on the **HOME** screen to access the **INFORMATION** area.

The page displays the following menus:

- **DATE/TIME**
- **SERVICE (PARAMETERS)**
- **INTERNAL DATA**
- **LANGUAGE**

Push **SERVICE (PARAMETERS)**

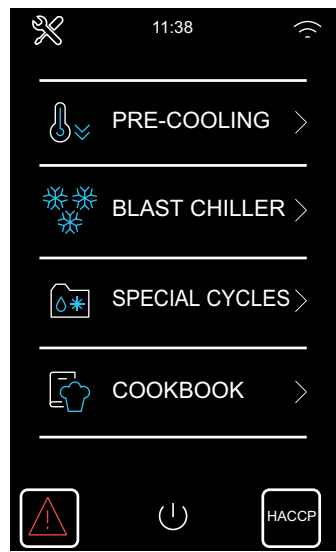
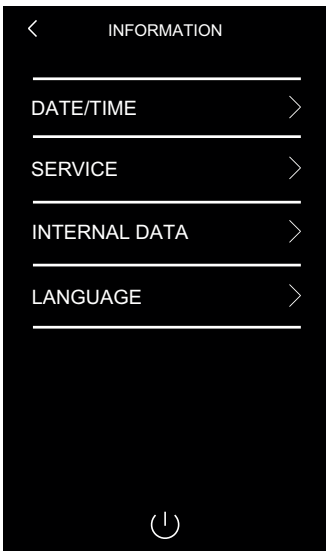
the following functions are available:

- PARAMETER configuration, by means of password (-19)
- Default value refresh (restricted and not selectable)
- OEM Recipe refresh by means of password (99)

PARAMETER

NB only the highlighted parameters can be modified by maintenance service. The other parameters can be modified only after reference/authorization by our technical department.

ABF= blast chiller **MF** = Multifunctional

PAR.	ABF	MF	MIN.	MAX.	U.M.	ANALOG INPUTS
CA1	0	0	-25	25	°C/°F(1)	chamber probe calibration
CA2	0	0	-25	25	°C/°F(1)	evaporator probe calibration (if P4=1)
CA3	0	0	-25	25	°C/°F(1)	condenser probe calibration (if P5=1)
CA4	0	0	-25	25	°C/°F(1)	core probe 1 calibration
CA5	0	0	-25	25	°C/°F(1)	core probe 2 calibration (if P9>1)
CA6	0	0	-25	25	°C/°F(1)	core probe 3 calibration (if P9>1)
P0	1	1	0	1	- - - -	probe type 0 = PTC 1 = NTC
P2	0	0	0	1	- - - -	temperature unit of measure 0 = °C 1 = °F
P3	1	1	0	3	- - - -	core probe type 0= deactivated 1= single probe 2= multi core probe 3= multi-sensor probe See also P9
P4	1	1	0	1	- - - -	evaporator probe activation 0 =no 1 = yes
P5	1	1	0	1	- - - -	condenser probe activation 0 =no 1 = yes
P9	1	1	1	3	- - - -	if P3=1, P9 must be set at 1; if P3=2, the number set for P9 corresponds to the number of available core probes (from 1 to 3); if P3=2 the number set for P9 corresponds to the available number of sensor on the core probe
PAR.	ABF	MF	MIN.	MAX.	U.M.	MAIN REGULATOR
r0	3	3	1	15	°C/°F(1)	chamber setpoint differential in blast-chilling, shock-freezing, sanification, ice-cream hardening and customized cycles
r1	90	90	1	500	min	tim-based blast chilling duration
r2	240	240	1	500	min	time-based shock freezing duration
r3	3	3	-50	99	°C/°F(1)	product temperature for temperature-based blast-chilling end and for soft phase end in temperature-based soft shock freezing; see also parameter r5
r4	-18	-18	-50	99	°C/°F(1)	product temperature for temperature-based shock freezing end; see also parameter r6
r5	90	90	1	500	min	maximum allowed duration for temperature-based blast chilling; see also parameter r3
r6	240	240	1	500	min	maximum allowed duration for temperature-based shock freezing; see also parameter r4
r7	-2	-2	-50	99	°C/°F(1)	chamber temperature setpoint during blast chilling and during soft phase of soft shock freezing; see also parameter r0

ENGLISH

r8	-40	-40	-50	99	°C/°F(1)	chamber temperature setpoint during shock freezing and during ice-cream hardening; see also parameter r0
r9	-20	-20	-50	99	°C/°F(1)	chamber temperature setpoint during hard phase of hard blast chilling; see also parameter r0
r10	2	2	-50	99	°C/°F(1)	chamber temperature setpoint during storage following blast chilling, hard blast chilling and continuous cycle; see also parameter r0
r11	-20	-20	-50	99	°C/°F(1)	chamber temperature setpoint during storage following shock freezing and soft shock freezing, see also parameter r0
r12	0	0	-50	99	°C/°F(1)	chamber temperature setpoint during precooling; see also parameter r0
r13	15	15	-50	99	°C/°F(1)	product temperature for hard phase end of temperature-based hard blast chilling
r14	60	60	10	100	%	hard phase duration in time-based hard blast chilling, i.e. value percentage set with parameter r1; soft phase duration in time-based soft shock freezing, i.e. value percentage set with parameter r2
r15	65	65	-50	199	°C/°F(1)	product temperature below which the maximum duration count for temperature-based blast chilling or shock freezing starts.
r17	5	5	0	99	°C/°F(1)	minimum variance between product temperature and chamber temperature leading to consider the first phase of the test for correct core probe insertion as successfully completed 0= test is deactivated and core probe is considered as always inserted
r18	60	60	10	999	s	duration of the second phase of the test to check core probe correct insertion
r19	-40	-40	-50	99	°C/°F(1)	chamber temperature setpoint for sanitation first phase
r20	-20	-20	-50	99	°C/°F(1)	product temperature setpoint for sanitation first phase and chamber temperature setpoint for sanitation second phase
r21	24	24	0	24	h	sanitization second phase duration
r22	-20	-20	-50	99	°C/°F(1)	chamber temperature setpoint for sanitation third phase
r23	5	5	1	99	h	maximum duration sanitation first phase
r24	10	10	1	400	min	ice-cream hardening cycle duration
r25	25	25	-50	99	°C/°F(1)	chamber temperature initial setpoint for low load thawing
r26	30	30	-50	99	°C/°F(1)	chamber temperature initial setpoint for medium load thawing
r27	35	35	-50	99	°C/°F(1)	chamber temperature initial setpoint for high load thawing
r28	10	10	-50	99	°C/°F(1)	chamber temperature final setpoint for low load thawing
r29	12	12	-50	99	°C/°F(1)	chamber temperature final setpoint for medium load thawing
r30	15	15	-50	99	°C/°F(1)	chamber temperature final setpoint for high load thawing
r31	3	3	-50	99	°C/°F(1)	chamber temperature setpoint for storage after thawing
r32	240	240	1	999	min	thawing duration for low load
r33	480	480	1	999	min	thawing duration for medium load
r34	720	720	1	999	min	thawing duration for high load
r35	-15	-15	-50	99	°C/°F(1)	chamber temperature setpoint for customized blast chilling
r36	10	10	-50	99	°C/°F(1)	product temperature setpoint for customized blast chilling
r37	240	240	1	999	min	time-based customized blast chilling duration
r38	5	5	-50	99	°C/°F(1)	chamber temperature setpoint for storage after customized blast chilling
r39	80	80	-50	99	°C/°F(1)	maximum settable chamber temperature setpoint
PAR.	ABF	MF	MIN.	MAX.	U.M.	COLD REGULATOR (valid parameters only if F12=2 or 3)
rC0	2	2	1	15	°C/°F(1)	parameter rC3 differential
rC3	5	5	-50	99	°C/°F(1)	chamber temperature setpoint for blast-chilling phase (for leavening cycle)
rC4	1	1	0	10	°C/°F(1)	relative cold threshold in neutral zone for all leavening phases
rC5	5	5	-50	++	°C/°F(1)	chamber temperature setpoint for storage phase in retarding-proofing cycle
PAR.	ABF	MF	MIN.	MAX.	U.M.	HEAT REGULATOR (valid parameters only if E12=2 or 3)
rH0	2	2	1	15	°C/°F(1)	parameter rH3 rH4 rH5 rH10 rH 13 differential
rH3	20	20	-50	99	°C/°F(1)	chamber temperature setpoint for proofing phase
rH4	30	30	-50	99	°C/°F(1)	chamber temperature setpoint for leavening phase
rH5	25	25	-50	99	°C/°F(1)	chamber temperature setpoint for conservation phase
rH6	1	1	0	10	°C/°F(1)	relative heat threshold in neutral zone for all leavening phases
rH7	120	120	0	999	Min	blast-chilling phase duration (for leavening cycle)
rH8	180	180	0	999	Min	proofing phase duration
rH9	180	180	0	999	Min	leavening phase duration
rH10	80	80	-50	99	°C/°F(1)	chamber temperature setpoint for slow cooking
rH11	60	60	-50	99	°C/°F(1)	product temperature setpoint for slow cooking
rH12	60	60	0	999	Min	slow cooking duration
rH13	60	60	-50	99	°C/°F(1)	chamber temperature setpoint for conservation
rH14	60	60	1	600	s	heater cycle time in leavening
rH15	30	30	1	10	s	heater ON time in leavening
rH16	1	1	0	10	°C/°F(1)	relative neutral zone threshold for thawing
rH17	2	2	1	15	°C/°F(1)	chamber setpoint differential in thawing for heater activation
rH18	2	2	1	15	°C/°F(1)	chamber setpoint differential in thawing for compressor activation
rH19	60	60	1	600	s	heater cycle time in thawing

ENGLISH

rH20	60	60	1	10	s	heater ON time in thawing
rH21	1	1	0	10	°C/°F(1)	neutral zone threshold in storage phase
PAR.	ABF	MF	MIN.	MAX.	U.M.	HUMIDITY REGULATOR (valid parameters only if E12=1)
rU1	7	7	-50	99	°C/°F(1)	chamber temperature below which humidification is inhibited
rU2	300	300	1	600	s	cycle time for humidifier start in leavening and slow cooking
rU3	180	180	1	600	s	humidifier ON time within rU2 cycle time to generate 100% humidity in chamber
rU4	0	0	0	1	----	humidification control activation in blast-chilling and storage phase (for leavening cycle) 0 = no 10 = yes
rU5	60	60	0	100%	preset %	humidification in blast chilling (for leavening cycle) if parameter rU4=1
rU6	60	60	0	100%	preset %	humidification in storage (retarding-proofing cycle)
rU7	80	80	0	100%	preset %	humidification in proofing
rU8	80	80	0	100%	preset %	humidification in leavening
rU9	80	80	0	100%	preset %	humidification in conservation
rU10	80	80	0	100%	preset %	humidification in slow cooking
rU11	80	80	0	100%	preset %	humidification in conservation after slow cooking
PAR.	ABF	MF	MIN.	MAX.	U.M.	COMPRESSOR PROTECTIONS
C0	0	0	0	240	min	minimum time between power recovery after power shortage happening during a running cycle and compressor starting
C2	5	5	0	240	min	minimum time between compressor turning off and following turning on
C3	0	0	0	240	min	minimum time compressor ON (compressor 1 and compressor 2)
C4	10	10	0	240	min	OFF compressor time during chamber probe error (code "CHAMBER PROBE". Happens during storage after blast chilling and shock freezing. See also parameters C5 and C9
C5	10	10	0	240	min	OFF compressor time during chamber probe error (code "CHAMBER PROBE"). Happens during storage after blast chilling; see also parameter C4
C6	65	65	0	199	°C/°F(1)	condenser temperature above which overheated condenser alarm is activated (code "OVERHEATED COND").
C7	75	75	0	199	°C/°F(1)	condenser temperature above which compressor block alarm (code "BLOCKED COMP") is activated, after C8 time is elapsed.
C8	1	1	0	15	min	compressor block alarm (code "BLOCKED COMP") activation delay from passing of C7 threshold
C9	30	30	0	240	min	compressor ON time during chamber probe error (code "CHAMBER PROBE"), happening during storage after shock freezing; see also parameter C4.
C10	5	5	0	240	min	compressor OFF time during chamber probe error (code "CHAMBER PROBE"), happening during storage after shock freezing; see also parameter C4
PAR.	ABF	MF	MIN.	MAX.	U.M.	DEFROSTING
d0	8		0	99	h	defrosting interval 0= defrosting at intervals will never be activated
d1	1	1	0	4	----	defrosting type 0= electrical (during defrosting, compressor will be turned off; defrosting output will be activated and evaporator fan will be turned off) 1= hot gas (during defrosting, compressor will be turned on, defrosting output will be activated and evaporator fan will be turned off) 2= air (during defrosting, compressor will be turned off and evaporator output will be activated; evaporator fan will be turned on regardless of door conditions i.e. regardless of door microswitch status) 3= air with open door (during defrosting, compressor will be turned off and defrosting output will be activated; evaporator fan will be turned on on condition that the door is open, i.e. on condition that door microswitch is active and that parameter i0 is set to a different value than 0)
d2	8	8	-50	99	°C/°F(1)	evaporator temperature for defrosting end; see also parameter d3
d3	15	15	0	99	min	if evaporator probe is not present (P4=0), it defines defrosting duration; if evaporator probe is present (P4=1), it defines maximum defrosting duration; see also parameter d2 0= defrosting will never be activated; evaporator fan will be turned on if the door is open, i.e. if door microswitch input is active and parameter i0 is set to a different value than 0)
d4	0	0	0	1	----	defrosting activation at blast chilling start and at shock freezing start 0 = no 1 = yes
d5	0	0	0	99	min	defrosting delay from storage start 0 = defrosting will be activated after the time set with parameter d0 has elapsed
d7	2	2	0	15	min	dripping delay after a defrosting in which compressor and evaporator fan will remain turned off and defrosting output will be deactivated
d15	0	0	0	99	min	minimum consecutive duration of compressor ON for hot gas defrosting start if d1 is set to 1
d16	0	0	0	99	min	pre-dripping time if d1 is set to 1 (hot gas defrosting), in which compressor and evaporator fan will be turned off and defrosting output will remain activated
PAR.	ABF	MF	MIN.	MAX.	U.M.	TEMPERATURE ALARMS
A1	10	10	0	99	°C/°F(1)	chamber temperature below which inimum alarm temperature is activated (regarding working setpoint, i.e. "r10+A1" during storage after blast chilling and "r11+A1" during storage after shock freezing; (code "LOW TEMPERATURE"); see also parameter A11.
A2	1	1	0	1	----	minimum temperature alarm activation (code "LOW TEMPERATURE"): 0 = no 1 = yes
A4	10	10	0	99	°C/°F(1)	chamber temperature above which maximum temperature alarm is activated (regarding working setpoint, i.e. "r10+A4" during storage after blast chilling and "r11+A4" during storage after shock freezing (code "HIGH TEMPERATURE"; see also parameter A11 (4)
A5	1	1	0	1	----	maximum temperature alarm activation (code "HIGH TEMPERATURE"): 0 = no 1 = yes
A7	30	30	0	240	min	temperature alarm delay (code "HIGH TEMPERATURE" and code "LOW TEMPERATURE")
A8	30	30	0	240	min	maximum temperature alarm delay (code "HIGH TEMPERATURE") from evaporator fan stop end and from storage start

ENGLISH

A10	5	5	0	240	min	power shortage duration causing power failure alarm memorization (code "POWER FAILURE") when power will be resumed. 0 = alarm will not be signalled
A11	2	2	1	15	°C/°F(1)	parameter A1 and A4 differential
A12	5	5	0	240	s	buzzer activation duration during blast chilling end and shock freezing end
A13	60	60	0	240	s	buzzer activation duration for alarm
PAR.	ABF	MF	MIN.	MAX.	U.M.	EVAPORATOR AND CONDENSER FANS
F1	70	70	-50	99	°C/°F(1)	evaporator temperature above which evaporator fan is turned off during precooling/blast chilling/shock freezing/sanification/ice-cream hardening/blast chilling (for leavening cycle); see also parameter F8
F3	0	0	0	15	min	evaporator fan stop duration (during evaporator fan stop, compressor can be turned on; defrosting output will remain deactivated and evaporator fan will remain turned off)
F8	2	2	1	15	°C/°F(1)	F1 and F17 differential
F15	15	15	0	240	s	evaporator fan delay from door closing , i.e. from door microswitch input deactivation
F17	90	90	-50	199	°C/°F(1)	chamber temperature above which evaporator fan is turned off during precooling/blast chilling/shock freezing/sanification/ice-cream hardening/blast chilling (for leavening cycle); see also parameter F8
F19	30	30	0	100	%	evaporator fan minimum speed calibration
F20	100	100	0	100	%	evaporator fan maximum speed calibration
F21	100	100	0	100	%	peak speed
F22	10	10	0	10	s	peak time
F23	5	5	1	5	----	fan speed in blast chilling and in shock-freezing soft phase
F24	5	5	1	5	----	fan speed in blast-chilling hard phase
F25	5	5	1	5	----	fan speed in shock freezing and ice-cream hardening
F26	5	5	1	5	----	fan speed in positive storage
F27	5	5	1	5	----	fan speed in negative storage
F28	5	5	1	5	----	fan speed in precooling
F29	1	1	1	5	----	fan speed in first phase of thawing
F30	1	1	1	5	----	fan speed in first phase of thawing
F31	1	1	1	5	----	fan speed in third phase of thawing
F32	1	1	1	5	----	fan speed in fourth phase of thawing
F33	1	1	1	5	----	fan speed in fifth phase of thawing
F34	1	1	1	5	----	fan speed in storage after thawing
F35	5	5	1	5	----	fan speed in sanification first phase (blast chilling)
F36	5	5	1	5	----	fan speed in sanification second phase (conservation)
F37	5	5	1	5	----	fan speed in sanification third phase (storage)
F38	5	5	1	5	----	fan speed in customized blast chilling
F39	5	5	1	5	----	fan speed in customized storage
F40	5	5	1	5	----	fan speed in slow cooking
F41	5	5	1	5	----	fan speed in conservation after slow cooking
F42	5	5	1	5	----	fan speed in blast chilling (for leavening cycle)
F43	5	5	1	5	----	fan speed in proofing
F44	5	5	1	5		fan speed in leavening
F45	5	5	1	5		fan speed in storage (for leavening cycle)
F46	35	35	0	99	°C/°F(1)	condenser temperature above which condenser fan is turned on
F47	5	5	0	240	s	condenser fan turning off delay from compressor turning off (only if condenser probe is not present)
F48	---	---	0	1	0	condenser fan status during defrosting 0 = off 1 = on
F49	0	0	0	1	---	fan operation mode in storage 0 = parallel to compressor 1 = always on
F50	0	0	0	1	---	fan operation mode in slow cooking 0= always on 1= on if heaters are on with ON-OFF cycles if heaters are off
F51	180	180	0	999	s	fan OFF time in heating for operation with F50 = 1
F52	60	60	0	999	s	fan ON time in heating for operation with F50 = 1
F53	1	1	1	5	---	minimum settable fan speed for all cycles except slow cooking. Attention: check setting coherence with parameters from F23 to F45
F54	2	2	1	5	---	minimum settable fan speed for slow cooking. Attention: check setting coherence with parameters from F23 to F45
PAR.	ABF	MF	MIN.	MAX.	U.M.	DIGITAL INPUTS
i0	1	1	0	2	----	effect caused by door opening, i.e. by door microswitch activation 0 = no effect and no warning 1 = compressor, evaporator fan, defrosting heaters, heating heaters and humidification will be turned off and chamber light will be turned on. After the time set by parameter i2 is elapsed, the appliance will display the alarm and the buzzer will be activated (until the door will be closed); see also parameter F15
i1	1	1	0	1	----	door microswitch input polarity 0 = normally open (active input with closed contact) 1 = normally closed (active input with open contact)
i2	5	5		120	min	door opening duration for open door alarm recording -1 = alarm will not be signalled
i5	-	-	-	-	-	restricted

ENGLISH

i6	1	1	0	1	----	high pressure input polarity 0 = normally open (active input with closed contact) 1 = normally closed (active input with open contact)
i7	5	5		240	s	high pressure alarm warning delay -1 = alarm will not be signalled
i8	-	-	-	-	-	restricted
i9	1	1	0	1	----	low pressure input polarity 0 = normally open (active input with closed contact) 1 = normally closed (active input with open contact)
i10	5	5		240	s	low pressure alarm warning delay -1 = alarm will not be signalled
i11	0	0	0	1	----	thermal protection input polarity 0 = normally open (active input with closed contact) 1 = normally closed (active input with open contact)
i12	5	5		240	s	thermal protection alarm warning delay -1 = alarm will not be signalled
i13	-	-	-	-	-	restricted
PAR.	ABF	MF	MIN.	MAX.	U.M.	DIGITAL OUTPUTS
u01c	1	1	0	12	----	utility managed by output K1 0. Not used 1. Compressor 1 2. Compressor 2 3. Defrosting 4. Evaporator Fans 5. Condenser Fans 6. Door Heater 7. Defrosting Heater 8. Alarm 9 Pump-down Valve 10. Core Probe Heating 11. UV Lamp 12. Chamber Light 13. Chamber Heater (only for relay from u10c to u13c) 14. Steam generator (only for relay from u10c to u13c) 15. Steam injection (only for relay from u10c to u13c)
u02c	3	3	0	12	----	utility managed by output K2 = Defrosting
u03c	4	4	0	12	----	utility managed by output K3 = evaporator fans
u04c	5	5	0	12	----	utility managed by output K4 = condenser fans
u05c	6	6	0	12	----	utility managed by output K5 = door heater
u06c	0 opt 7	7	0	12	----	utility managed by output K6 = defrosting heater
u07c	8	8	0	12	----	utility managed by output K7 = alarm
u08c	9	9	0	12	----	utility managed by output K8 = pump-down electrovalve
u09c	0 opt 11	0 opt 11	0	12	----	utility managed by output K9 = UVC lamp (opt.)
u10c	13	13	0	15	----	utility managed by output K10 (if MULTI expansion is present) = heating heater
u11c	14	14	0	15	----	utility managed by output K11 (if MULTI expansion is present) = steam generator
u12c	15	15	0	15	----	utility managed by output K12 (if MULTI expansion is present) = steam injection
u13c	0	0	0	15	----	utility managed by output K13 (if expansion is present) = same configurations as defined in parameter u01c
u5	2	2	-50	99	°C/°F(1)	chamber temperature above which door heaters are turned off
u6	10	10	1	240	min	UV light turning-on duration for sterilisation cycle
u7	40	40	-50	199	°C/°F(1)	core-probe end-heating temperature; see also parameter u8
u8	0	0	0	240	min	core-probe maximum heating duration; see also parameter u7 0 = core-probe heating is deactivated
u9	-	-	-	-	-	restricted
u11	1	1	0	1	----	evaporator fan activation during sterilisation (0=no 1=yes)
u12	10	10	0	999	s	compressor turning-off delay from pump-down valve deactivation (pump-down is turning off)
u13	25	25	1	99	m	drying duration
PAR.	ABF	MF	MIN.	MAX.	U.M.	SERIAL COMMUNICATION (type RS-485 serial port with MODBUS communication protocol) + EVLINK WIFI
PA1	426	426	-99	999	----	EVconnect/EPoCA 1st level password
PA2	824	824	-99	999	----	EVconnect/EPoCA 2nd level password
bLE	1	1	0	99	----	Serial port configuration for connectivity 0 = free 1 = force for EVconnect or for EPoCA 2-99 = EPoCA local network address
L1	5	5	1	240	min	data recording interval during main cycles; interval is the same both for internal data-logger and for EVLINK
LA	247	247	1	247	----	appliance address
Lb	3	3	0	3	----	baud rate 0 = 2.400 baud 1 = 4.800 baud 2 = 9.600 baud 3 = 19.200 baud
LP	2	2	0	2	----	odd-even 0 = none 1 = odd 2 = even
PAR.	ABF	MF	MIN.	MAX.	U.M.	MISCELLANEA
E7	0	0	0	1	----	keyboard lock" function activation mode 0 = not activated function 1 = automatic with temporary effect (keyboard will automatically lock after 60s from last key operation during the execution of a cycle)
E8	60	60	30	600	s	keyboard lock timeout
E9	1	1	0	1	----	pre-loaded splash-screen visualization after electrical power is resumed (0 = no 1 = yes)
E12	0	3	0	3	----	Function activation with expansion module 0 = no expansion module 1 = slow cooking only 2 = retarding-proofing only 3 = slow cooking + retarding proofing Attention: the modification of this parameter will automatically reboot the appliance
E13	0	0	0	1	----	appliance type 0= "blast-chiller" home 1 = "multifunctional" home Attention: the modification of this parameter will automatically reboot the appliance
E14	0	0	0	1	----	operation mode in case of core-probe insertion test fail 0 = time-based 1 = with core probe
E15	0	0	1	0	----	adjusted OEM recipe saving mode 0 = on user's recipe list 1 = on user's recipe list + OEM recipe overwriting
E16	1	1	0	1	----	ventilation mode 0 = without phase cut 1 = with phase cut
E17	0	0	0	1	----	sterilization type 0 = UV lamp; 1 = ionization

ENGLISH

E18	0	0	0	2		state of ionization cycle from passage of conservation cycle; 0 = keep the previous state; 1 = off; 2 = on
E19	60	60	0	240	min	time out ionizer operation in storage

ABF 5P-7P

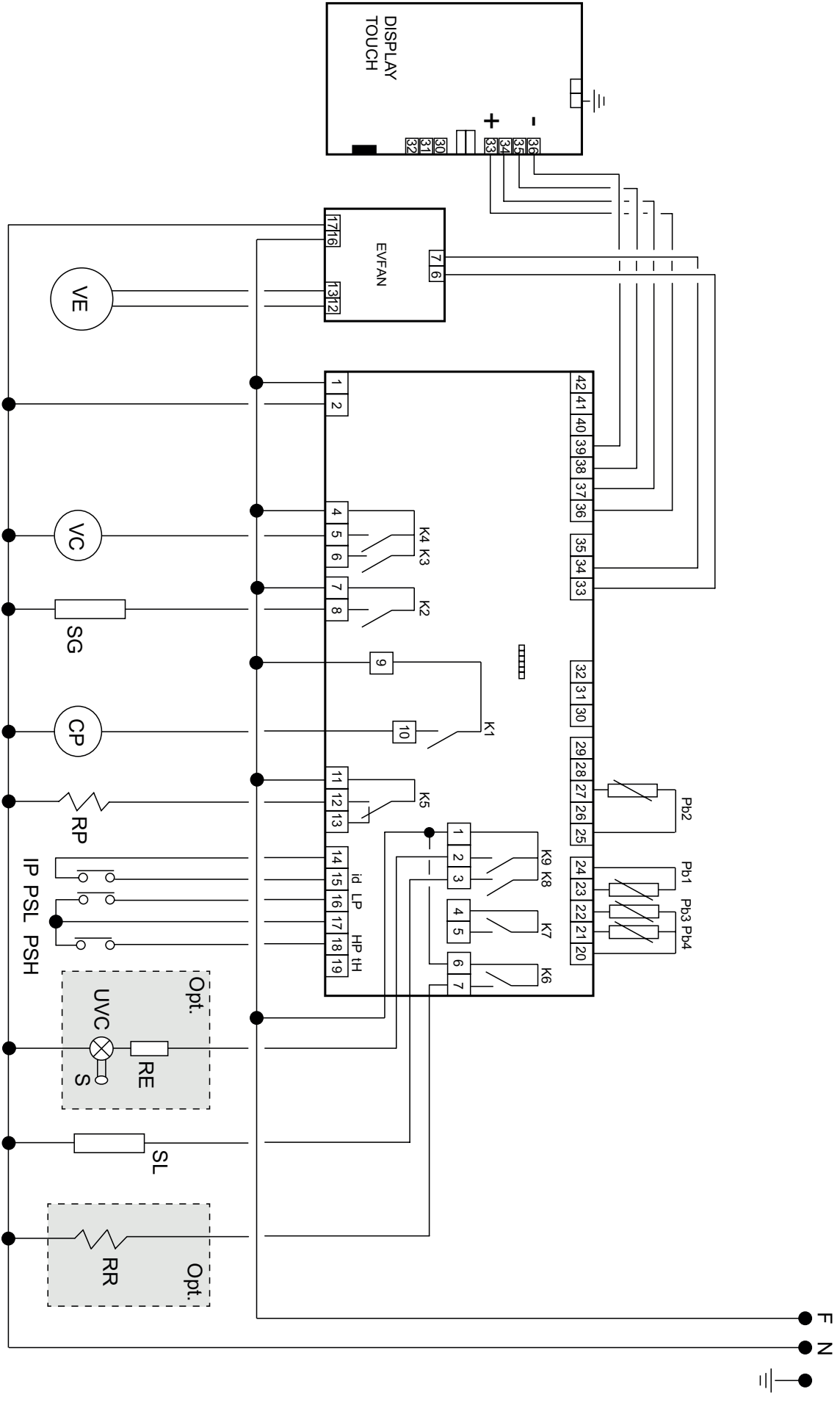

U | RR | VE | VE | SG | SL | VC | RP | T1 | T2 | T3 | RC | N | N | N

ABF 5P-7P MULTIFUNZIONE - MULTIFUNCTION

U | RR | VE | VE | SG | SL | VC | RP | T1 | T2 | T3 | RC | N | N | N

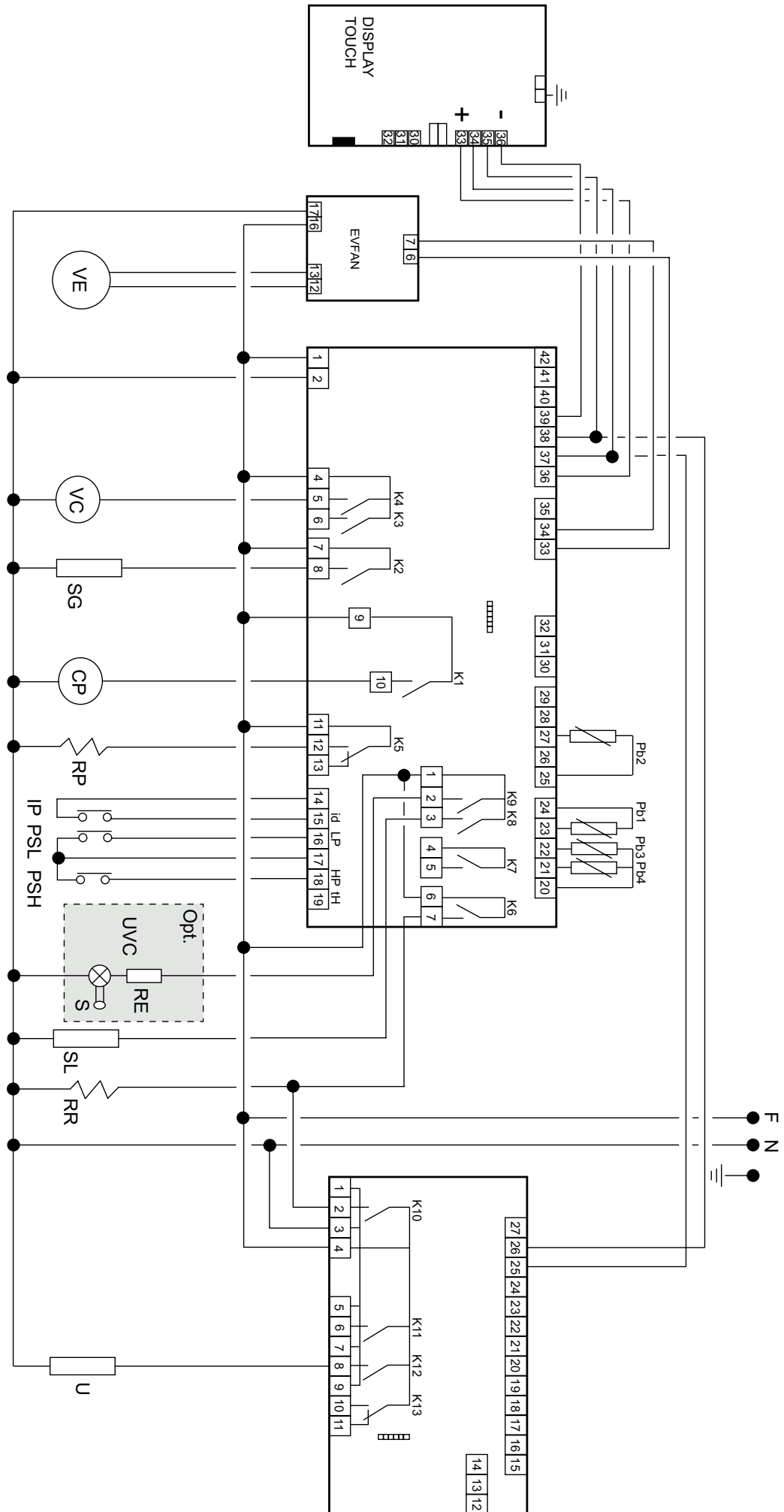

230/1/50-60HZ

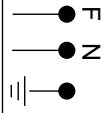

ABF 10P-15P-20P

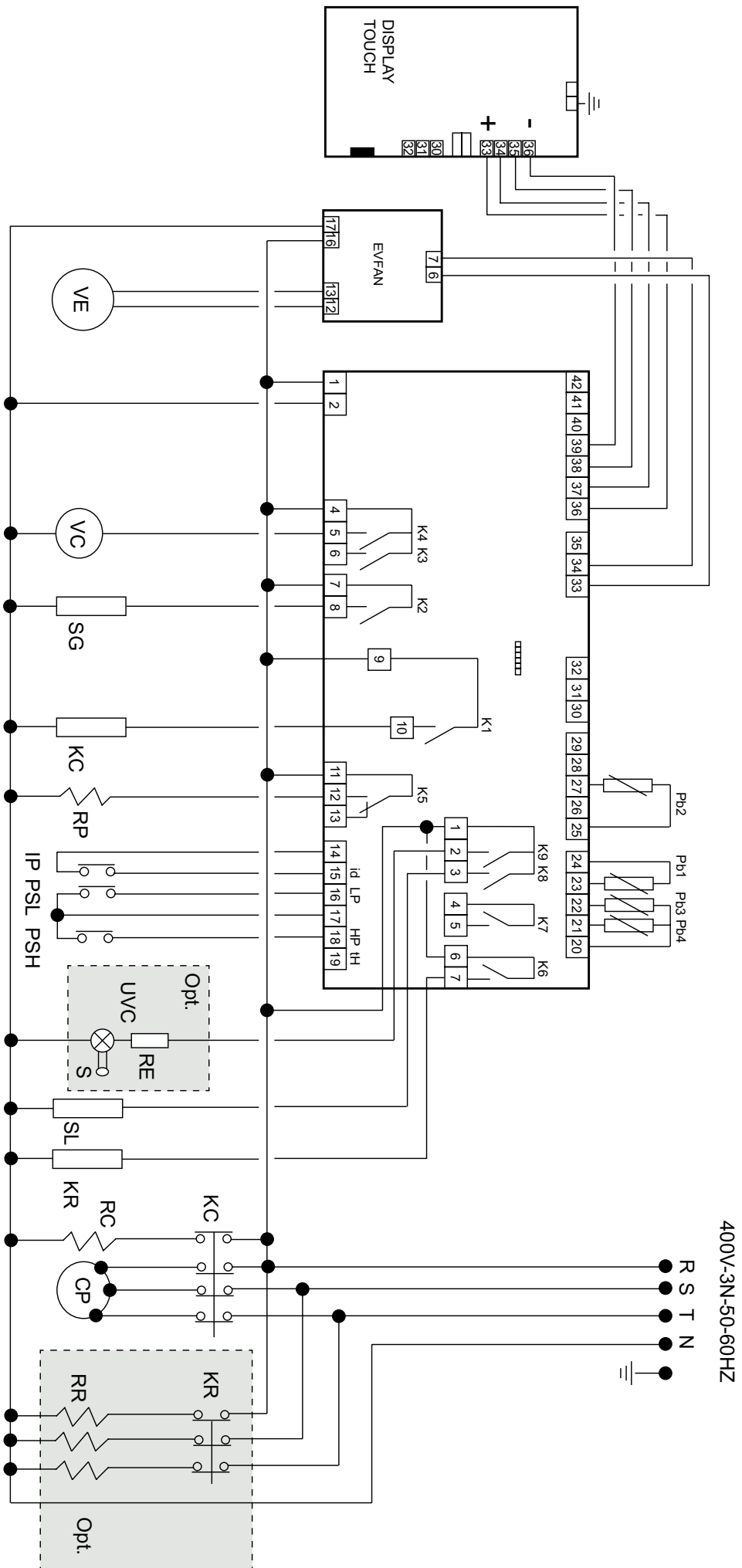

ABF 10P-15P-20P MULTIFUNZIONE - MULTIFUNCTION

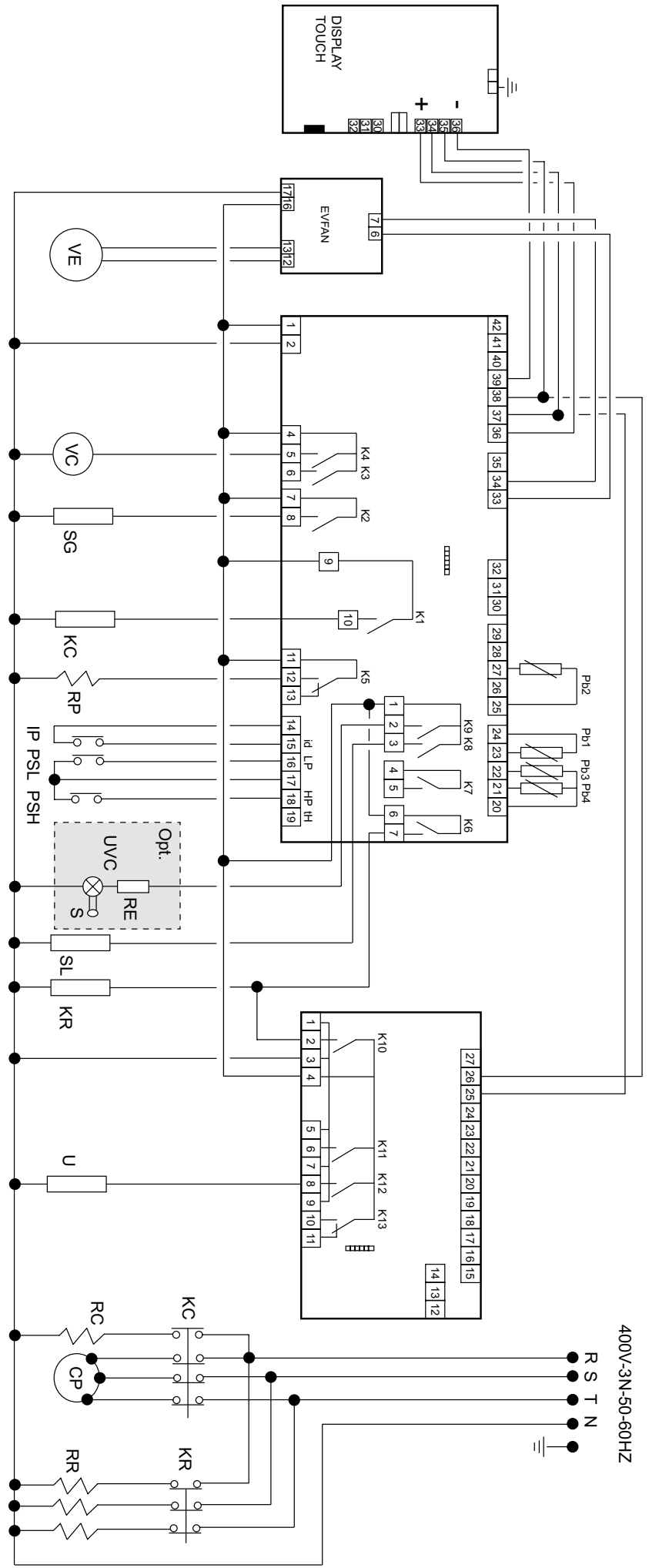

U | RR | VE | VE | SG | SL | VC | RP | T1 | T2 | T3 | RC | N | N | N

COMPONENT LIST

CP- Compressor
KC - Compressor Relay
RC - Crankcase Heater
VC - Condenser Fan
SL - Liquid Solenoid Electrovalve
VE - Evaporator Fan
EVFAN - Fan Speed Control Module
SG - Defrosting Solenoid Electrovalve
RR- Defrosting and Multifunctional Heater
KR - Defrosting and Multi Heater Relay
RE - UVC Lamp Power Supply (optional)
S - UVC Lamp Starter (optional)
UVC- UVC Lamp (optional)
IP- Door Microswitch
PSL - Low Pressure Switch
PSH- High Pressure Switch
Pb1 - Chamber Probe
Pb2 - Core-Probe Probe
Pb3 - Evaporator Probe
Pb4 - Condenser Probe



EVERLASTING

EVERLASTING s.r.l.

46029 SUZZARA (MN) - ITALY - Strada Nazionale della Cisa km.161

Tel.0376/521800 (4 linee r.a.) - Telefax 0376/521794

<http://www.everlasting.it> - E-mail:everlasting@everlasting.it