

Use and maintenance manual

EVERLASTING

BLAST CHILLERS / SHOCK FREEZERS

BASIC TRAY



Thank you for choosing this product.

Please read the warnings contained in this manual carefully, as they provide important information regarding safe operation and maintenance.

Make sure to keep this manual for any future reference by the various operators.

In some parts of the manual, the  symbol appears, indicating an important warning that must be observed for safety purposes.

CHAPTER 1 BOUNDARY CHARACTERISTICS OF OPERATION

The blast chiller has been designed and built to operate in optimal conditions at temperatures of up to +43°C, with adequate air circulation. In places with characteristics that are different from the requirements, the stated performance cannot be guaranteed.

The supply voltage must be 230V +/- 10% 50Hz as standard, or as indicated on the EC label.

The following table shows the cooling and/or freezing capacity in kg.

Model	Blast chilling +90°C / +3°C	Rapid freezing +90°C / -18°C
BASIC TRAY MINI	7 Kg.	5 Kg.
BASIC TRAY 04	10 Kg.	7 Kg.
BASIC TRAY 05	16 Kg.	12 Kg.
BASIC TRAY 07	24 Kg.	16 Kg.
BASIC TRAY 10	33 Kg.	23 Kg.
BASIC TRAY 15	50 Kg.	35 Kg.

N.B.: the times and quantities in kg above are valid for products with a maximum thickness of 4 cm.

Maximum time: Positive chilling: 90 min, Freezing: 240 min

The blast chiller complies with the European directives as described in detail in the Annex “**EC Declaration of Conformity**”

The technical specifications of the blast chiller are listed on the CE label placed on the rear side of the body.

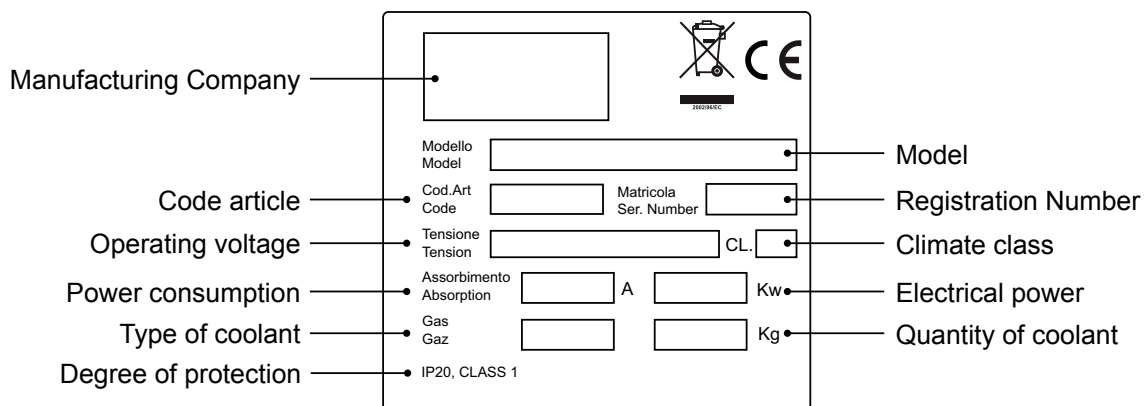



ATTENTION: any request for intervention, technical support and spare part must refer to the SERIAL NUMBER on the CE label, on the manual cover or on the compressor motor. The producer declines any responsibility for any improper or not reasonably foreseen usage of the blast chiller and for any operation carried out by neglecting the indications listed on the manual.



The main general safety standards are listed below:

- Do not use or place electrical devices inside the refrigerated compartments if they are not of the type recommended by the manufacturer
- Do not touch the blast chiller with damp or wet hands or feet
- Do not use the blast chiller barefoot
- Do not insert screwdrivers or other objects between the guards or moving parts
- Do not pull the power cord to unplug the blast chiller from the electricity network
- The blast chiller is not intended to be used by persons (including children) with physical or mental problems, or lack of experience and knowledge, unless they are controlled or instructed in using the unit by a person responsible for their safety. Children must be supervised to ensure that they do not play with the appliance.
- Before carrying out any cleaning or maintenance, disconnect the blast chiller from the mains power supply by turning off the main switch and pulling the plug
- In the event of failure and/or malfunction of the blast chiller, turn it off and to refrain from any attempt to repair or intervene directly. It is necessary to exclusively contact a qualified technician.

The blast chiller is composed of a modular single body insulated with expanded polyurethane with 42 kg/m³ density, internally covered in Stainless Steel AISI 304 and externally by different materials.

In the design and construction, all measures have been adopted to ensure a blast chiller that complies with safety and hygiene requirements, such as: rounded interior corners, deep drawing with drain on the outside for the condensate liquids, no rough surfaces, fixed guards on moving or dangerous parts.

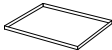
The products must be stored in observance of the load limits given in the table, in order to ensure an efficient circulation of air inside the blast chiller.

Load capacity						
Tipo/Type	BASIC TRAY MINI	BASIC TRAY 04	BASIC TRAY 05	BASIC TRAY 07	BASIC TRAY 10	BASIC TRAY 15
	GN 2/3 Nr° 3 Pitch 53 mm.	GN 1/1 Nr° 4 Pitch 70 mm. Nr° 5 Pitch 52,5 mm. Nr° 7 Pitch 35 mm.	GN 1/1 Nr° 5 Pitch 70 mm. Nr° 6 Pitch 52,5 mm. Nr° 9 Pitch 35 mm.	GN 1/1 Nr° 7 Pitch 70 mm. Nr° 9 Pitch 52,5 mm. Nr° 13 Pitch 35 mm.	GN 1/1 Nr° 10 Pitch 70 mm. Nr° 12 Pitch 52,5 mm. Nr° 19 Pitch 35 mm.	GN 1/1 Nr° 15 Pitch 70 mm. Nr° 20 Pitch 52,5 mm. Nr° 30 Pitch 35 mm.
	Nr° 2	Nr° 4	Nr° 6	Nr° 9	Nr° 12	Nr° 18
	-	Nr° 1	Nr° 2	Nr° 3	Nr° 4	Nr° 6



The installation must be performed exclusively by a qualified technician

1.1 It is prohibited to remove the guards and safety devices

It is absolutely forbidden to remove safety guards.

The manufacturer disclaims any liability for accidents due to failure to comply with this obligation.

1.2 Information on emergency operations in the event of fire

- disconnect the blast chiller from the power source or cut off the power supply
- do not use water jets
- use dry chemical or CO2 extinguishers

CHAPTER 2 CLEANING THE REFRIGERATOR

Since the blast chiller will be used to store food, cleaning is necessary for hygiene and health protection purposes. The cleaning of the blast chiller has already been carried out at the factory. It is suggested, however, to carry out an additional cleaning of the internal parts before use, making sure that the power cord is unplugged.

2.1 Cleaning the interior and exterior cabinet

For this purpose the following are indicated

- the cleaning products: water and mild, non-abrasive detergents. **DO NOT USE SOLVENTS AND THINNERS**
- methods for cleaning: wash the interior and exterior parts with warm water and mild soap or with a cloth or sponge with suitable products
- disinfection: avoid substances that can alter the organoleptic characteristics of the food
- rinsing: cloth or sponge soaked in warm water. **DO NOT USE WATER JETS**
- frequency: weekly is recommended, the user can set different frequencies depending on the type of food being stored.

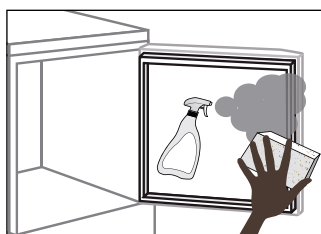

REMARK : Clean frequently the door seals.

Some preserved products could release some enzymes that could damage the seals causing its quick deterioration.

For the cleaning, use only specific products for this purposes, available also on request on our sales network.

2.2 Cleaning the condenser

The efficiency of the blast chiller is compromised by the clogging of the condenser, therefore it is necessary to clean it on a monthly basis. Before carrying out this operation, switch off the blast chiller, unplug the power cord and proceed as follows:

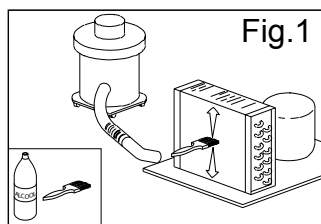

With the aid of a jet of air or dry brush, eliminate, in a vertical movement (Fig. 1), the dust and lint deposited on the fins. In the case of greasy deposits, we recommend using a brush moistened with special cleaning agents. At this point, proceed to clean as done with the models with fixed front panel. When the operation is completed, restart the blast chiller. Evaporators installed above the appliances are cartaphoresis-treated to reduce corrosion problems.



During this operation, use the following personal protective equipment: goggles, respiratory protection mask, chemically resistant gloves (gasoline-alcohol).

CHAPTER 3 PERIODIC CHECKS TO BE CARRIED OUT

The following are the points or units of the blast chiller that require periodic checks:

- integrity and efficiency of door seals
- integrity of the grilles in contact with food
- integrity of the fixing hinges of the doors
- integrity of the power cord of the blast chiller

3.1 PRECAUTIONS IN CASE OF LONG PERIODS OF INACTIVITY

A long period of inactivity is defined as a stoppage of more than 15 days.

It is necessary to proceed as follows:

- switch off the blast chiller and disconnect it from the power supply
- carry out a thorough cleaning of the interior cabinet, shelves, trays, guides and supports, paying special attention to critical points such as the joints and magnetic gaskets, as indicated in Chapter 2.
- leave the door partly open to prevent air stagnation and residual humidity

CHAPTER 4 PREVENTIVE MAINTENANCE**4.1 Restarting after a long period of inactivity**

Restarting after long inactivity is an event that requires preventive maintenance.

It is necessary to perform a thorough cleaning as described in chapter 2.

4.2 Control of the warning and control devices

We recommend that you contact your dealer for a service or maintenance contract that includes:

- cleaning of the condenser
- verification of the coolant load
- verification of the full cycle operation
- electrical safety

**CHAPTER 5 EXTRAORDINARY MAINTENANCE AND REPAIR**

All maintenance activities that have not been described in previous chapters are considered “Extraordinary Maintenance.” Extraordinary maintenance and repair are tasks reserved exclusively to the specialist personnel authorized by the manufacturer.

No liability is accepted for actions carried out by the user, by unauthorized personnel, or with the use of non-original replacement parts.

CHAPTER 6 TROUBLESHOOTING

Problems may occur, in the blast chiller, identified as shown in the table:

TROUBLE DESCRIPTION	POSSIBLE CAUSES	HOW TO REPAIR IT
the blast chiller does not turn on	no power supply	check the plug, socket, fuses, line
	other	contact technical support
the refrigeration unit does not start	the set temperature has been reached	set new temperature
	defrosting in progress	wait until the end of cycle / turn power off and on again
	control panel failed	contact technical support
	other	contact technical support
the refrigeration unit runs continuously but does not reach the set temperature	location is too hot	aerate more
	condenser is dirty	clean the condenser
	insufficient coolant	contact technical support
	stop the condenser fan	contact technical support
	insufficient sealing of doors	check the seals / provision of goods
	evaporator completely frosted	manual defrosting
	other	contact technical support
the refrigeration unit does not stop at the set temperature	command panel failed	contact technical support
	Pr1 temperature sensor failed	contact technical support
block of ice on the evaporator	misuse	see chapter 1.
	device to defrost	press the manual defrost
	defrost probe Pr3 damaged	contact technical support
accumulation of water or ice in the drip tray	drain clogged	clean the pipette and the drain
	blast chiller is not level	check levelling

CHAPTER 7 INSTRUCTIONS FOR REQUESTING ASSISTANCE

For any technical problem and for intervention, assistance and spare-part requests it is necessary to exclusively revert to one's dealer, providing the code and the serial number indicated on the specification label attached to the appliance.

CHAPTER 8 SAFETY AND ACCIDENT PREVENTION

The blast chiller has been built with suitable measures to ensure the safety and health of the user. The following are the measures taken to protect against mechanical risks:

- **stability:** The blast chiller, even with the grilles removed, has been designed and built in such a way that under the intended operating conditions, its stability is suitable for use without risk of overturning, falling or unexpected movement
- **surfaces, edges, corners:** the accessible parts of the blast chiller are, within the limits allowed by their functions, free of sharp angles and sharp edges, as well as rough surfaces likely to cause injury
- **moving parts:** were designed, constructed and arranged to avoid risks. Certain parts are equipped with fixed guards so as to prevent risks of contact which may result in injury

The following are the measures taken to protect against other risks:

- **electricity:** The blast chiller has been designed, built and equipped so as to prevent risks electrical, in accordance with the specific legislation in force
- **noise:** The blast chiller has been designed and built in such a way that risks resulting from the emission of airborne noise are reduced to the minimum level

8.1 safety devices adopted

It is absolutely forbidden (Fig. 2) :

- to tamper with or remove the evaporator housing casing that protects the user against the risk of being cut by the evaporator fins and the movement of the motor fan inside.
- remove the labels applied at the inner edge of the engine compartment, showing the technical specifications (1) and the instructions for grounding (2)
- remove the label applied on the evaporator guard and near the electrical wiring inside the engine compartment, which warns the user to turn off the power supply before working on the unit (3)
- to remove the labels applied inside the engine compartment, indicating grounding (4)
- to remove the label applied on the power cord, indicating the type of power supply (5)

The manufacturer declines any responsibility for the safety of the blast chiller if this were to happen.

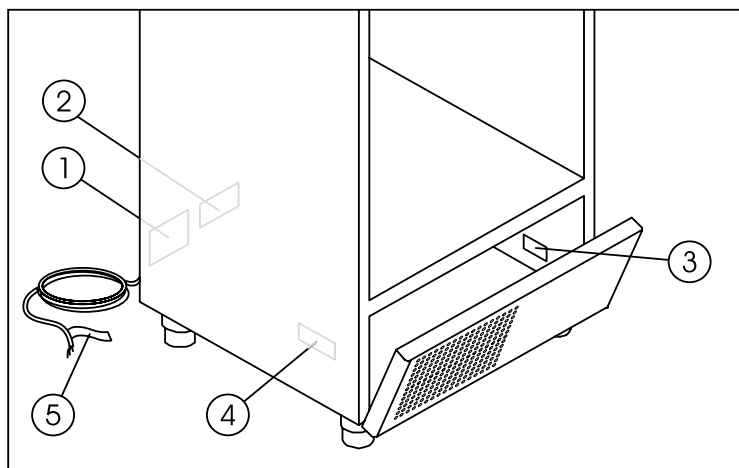

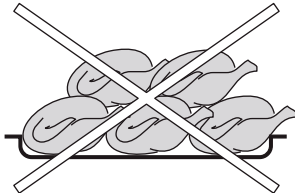

Fig.2

8.2 Indications for optimal operation

- do not obstruct the motor-compartment air intakes (place at minimum 50 cm from ceiling)
- place the foodstuffs on the appropriate shelves or containers. Do not place them directly on the bottom, or leaning against the walls, doors or fixed guards
- close the doors carefully
- always keep the defrost water drain hole clear of obstructions
- limit, to the extent possible, the frequency and duration of door opening. Each opening causes a change in the internal temperature
- perform periodically current maintenance (see chapter 3)

CORRECT LOAD BLAST CHILLER

AVOID overloading the blast chiller beyond the set limits shown in the table

NO	OK
	

Do not place the trays too close to each other so as to avoid uneven air circulation inside the blast chiller

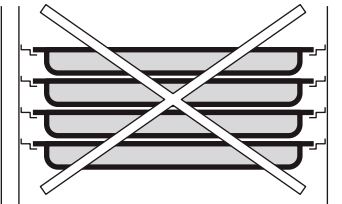
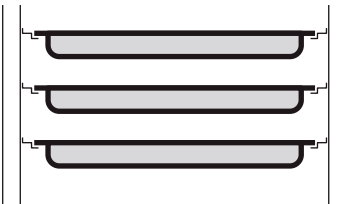
NO	OK
	

Do not place the trays too far away from the evaporator

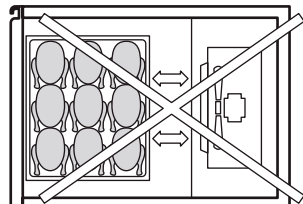
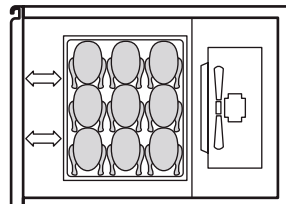
NO	OK
	

Do not concentrate the trays in one area of the blast chiller in case the load is not complete; distribute its height evenly

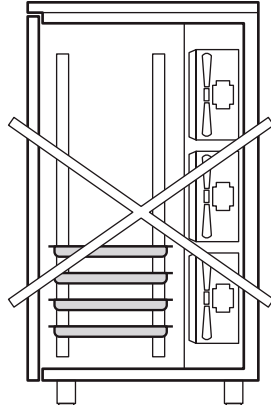
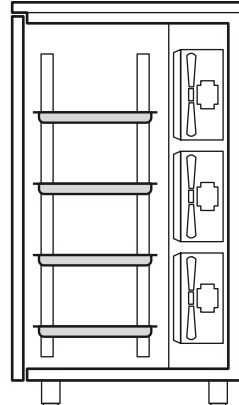
NO	OK
	

In case of interruption or failure of the power supply circuit, prevent the opening of the doors in order to maintain a uniform temperature inside the blast chiller.

If the problem persists longer than a few hours it is recommended to move the material to a suitable place.

CHAPTER 9 CONTROLS

9.1 Description of the controls and of the keys (Fig. 3)

The control panel is a digital thermoregulator for cold, and it is provided with 6 keys with specific functions:

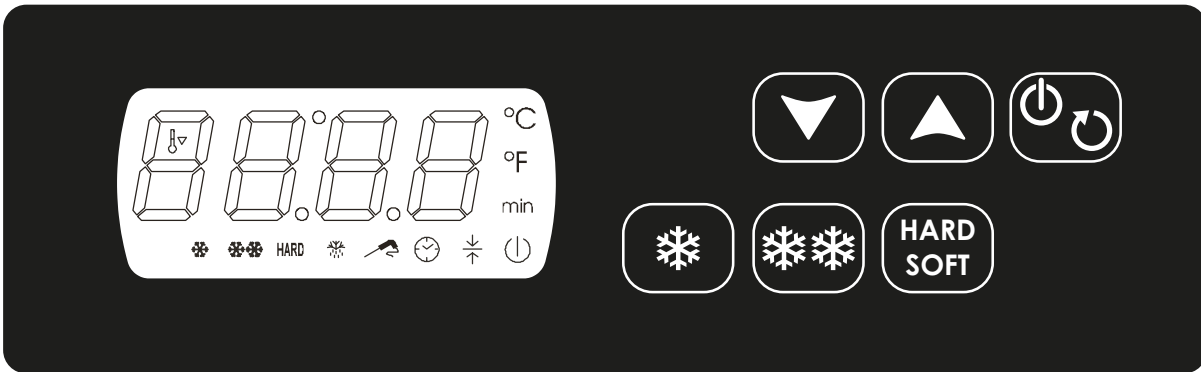







Fig.3

The control keys of the blast chiller are:





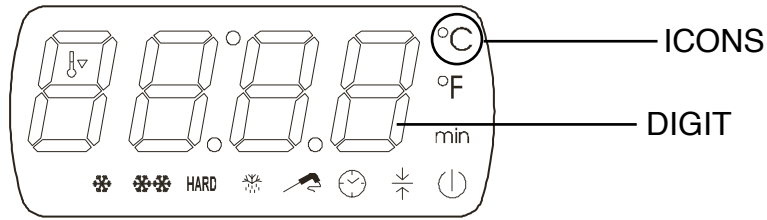

<p>START/STOP Key </p>	<p>Turns the blast chiller on or off, Pressing the key for 3 seconds and allows you to start or stop a cycle</p>
<p>DOWN Key </p>	<p>Reduces a value.</p>
<p>UP Key </p>	<p>Increases a value. When control board is in “ON” mode, it activates a manual defrosting cycle, pressing the key for 4 seconds. Only if the evaporator requires it.</p>
<p>HARD / SOFT Key </p>	<p>For selecting a Hard or Soft cycle.</p>
<p>FREEZING Key </p>	<p>Turns on a freezing cycle.</p>
<p>CHILLING Key </p>	<p>Turns on a positive chilling cycle.</p>

Nb. To silence the acoustic BUZZER, press and release any key.

Display

Visualization is carried out through a display where you can see four digits , once on, they turn blue, and twelve icons. For ease of reference, from now on the four digits will be designed as “display”, and each icon will be identified singularly.



<p>FREEZING Icon </p>	<ul style="list-style-type: none"> ▶ Flashes while selecting a freezing cycle ▶ Remains on during the freezing cycle
<p>CHILLING Icon </p>	<ul style="list-style-type: none"> ▶ Flashes while selecting a chilling cycle ▶ Remains on during the chilling cycle
<p>HARD Icon HARD CHILLING / FREEZING</p>	<ul style="list-style-type: none"> ▶ Flashes while selecting a Hard chilling or freezing cycle ▶ Remains on during the Hard chilling or freezing cycle
<p>Icons  TEMPERATURE-BASED CHILLING / TEMPERATURE-BASED FREEZING ICON</p>	<ul style="list-style-type: none"> ▶ Remains on while selecting: <ul style="list-style-type: none"> - A chilling cycle with core probe - A temperature-based freezing cycle ▶ Flashes during the test attesting that the core probe has been correctly inserted
<p>Icons  TIME CHILLING / TIME FREEZING ICON</p>	<ul style="list-style-type: none"> ▶ Remains on: <ul style="list-style-type: none"> - While selecting a time chilling cycle - While selecting a time freezing cycle
<p>STORAGE Icon </p>	<ul style="list-style-type: none"> ▶ Remains on during a storage cycle ▶ Flashes when displaying the room’s temperature
<p>DEFROSTING Icon </p>	<ul style="list-style-type: none"> ▶ Remains on while defrosting is being carried out
<p>PRECOOLING Icon </p>	<ul style="list-style-type: none"> ▶ Remains on while precooling is being carried out, and the room’s temperature has reached the pre-set parameters ▶ Flashes when precooling is being carried out, and the room’s temperature has not reached the pre-set parameters

FAHRENHEIT °F Icon	▶ Remains on when displaying a temperature measured in Fahrenheit degrees
CELSIUS °C Icon	▶ Remains on when displaying a temperature measured in Celsius degrees
MINUTES min Icon	▶ Remains on when displaying a time lapse expressed in minutes (e.g. the duration of a chilling / freezing cycle)
OFF Icon 	▶ Remains on when the device is connected and is OFF.

9.2 INSTRUCTION FOR USE

9.2.1 Start-up

Before starting up the blast chiller, please make sure that the power wiring and the connection have been performed as per dispositions in chapter 15.

When the control board is fed, a two-seconds lamp test is carried out.

There are 3 statuses of functioning:

OFF status:

▶ the blast chiller is being fed and is off	The display only shows the  icon, coloured in red.
---	---

ON/STAND-BY status:

▶ the blast chiller is being fed, is on and waiting for a working cycle to be carried out.	The display shows the room's temperature
--	--

RUN status:

▶ the blast chiller is being fed, is on, and a working cycle is being carried out.	The display shows the following information: <ul style="list-style-type: none"> ▶ if a chilling or freezing cycle with core probe is being carried out, the display shows the temperature detected by the probe ▶ if a chilling cycle or a time-based freezing is being carried out, the display shows the time remaining before the end of the current cycle ▶ if a storage cycle is being carried out, the display shows the room's temperature
--	--

9.2.2 Turn on/off

- Make sure the keyboard is not locked (chapter 11) and that no procedures are being carried out. Press the **START/STOP (ON/OFF)** key for 3 seconds to turn on and off the blast chiller.

The icon  turns on or off.

9.2.3 Operation

The blast chiller carries out chilling or freezing cycles, which can be Hard and Soft, time-based (setting the duration of the cycle) and temperature-based (checking the core temperature of the product via core probe).

Before each working cycle, a precooling may be carried out (Par. 9.2.12).

Before each cycle with a core probe, a test is carried out, to make sure the probe has been correctly inserted; if it is not inserted, time-based cycles will start automatically continued in time.

Each chilling / freezing cycle is followed by a storage cycle.

CHILLING TYPE	TEMPERATURE RANGE	SUGGESTED PRODUCTS
CHILLING SOFT	<ul style="list-style-type: none"> ▶ Core temperature of the product +90°C / +3°C ▶ The air temperature inside the room never goes below zero. 	Delicate, thin or small products such as vegetables, rice and fried products.
CHILLING HARD	<ul style="list-style-type: none"> ▶ Core temperature of the product +90°C / +3°C ▶ The air temperature inside the room reaches -20°C. 	Ideal for dense, fat, big in size or packed products.
FREEZING SOFT	<ul style="list-style-type: none"> ▶ Core temperature of the product +90°C / -18°C ▶ The air temperature inside the room reaches 0°C during the first phase, and reaches even -40°C during the second phase. 	Ideal for any foodstuff that, once frozen, is due to be stored for many weeks or months. Soft freezing is suitable for delicate and small products, needing a softer freezing process
FREEZING HARD	<ul style="list-style-type: none"> ▶ Core temperature of the product +90°C / -18°C ▶ The air temperature inside the room reaches -40°C 	Ideal for any foodstuff that, once frozen, is due to be stored for many weeks or months. Hard freezing is suitable for products that are big in size and are not affected by a fast temperature decrease.

DESCRIPTION OF CYCLES

POSITIVE CHILLING WITH CORE PROBE

<p>SOFT - Chapetr 9.2.4</p> <ul style="list-style-type: none"> ▶ Room temp. setpoint.: 0°C ▶ Core probe temp. setpoint.: 3°C <p align="center">+</p> <p align="center">SORING CYCLE</p> <ul style="list-style-type: none"> ▶ Setpoint Temp. room: 2°C 	<p>HARD - Chapetr 9.2.5</p> <p>a) 1st phase</p> <ul style="list-style-type: none"> ▶ Room temp. setpoint.: -20°C ▶ Core probe temp. setpoint.: 15°C <p>a) 2nd phase</p> <ul style="list-style-type: none"> ▶ Room temp. setpoint.: 0°C ▶ Core probe temp. setpoint.: 3°C <p align="center">+</p> <p align="center">STORAGE CYCLE</p> <ul style="list-style-type: none"> ▶ Room temp. setpoint.: 2°C
--	--

POSITIVE TIME-BASED CHILLING

<p>SOFT - Chapetr 9.2.6</p> <p>100% of time Soft chilling</p> <ul style="list-style-type: none"> ▶ Room temp. setpoint.: 0°C <p align="center">+</p> <p align="center">STORAGE CYCLE</p> <ul style="list-style-type: none"> ▶ Room temp. setpoint.: 2°C 	<p>HARD - Chapetr 9.2.7</p> <p>60% of time Hard chilling</p> <ul style="list-style-type: none"> ▶ Room temp. setpoint.: -20°C <p>40% of time Soft chilling</p> <ul style="list-style-type: none"> ▶ Room temp. setpoint.: 0°C <p align="center">+</p> <p align="center">STORAGE CYCLE</p> <ul style="list-style-type: none"> ▶ Room temp. setpoint.: 2°C
---	---

FREEZING WITH CORE PROBE

<p>SOFT - Chapetr 9.2.9</p> <p>a) 1st phase</p> <ul style="list-style-type: none"> ▶ Room temp. setpoint.: 0°C ▶ Core probe temp. setpoint.: +3°C <p>a) 2nd phase</p> <ul style="list-style-type: none"> ▶ Room temp. setpoint.: -40°C ▶ Core probe temp. setpoint.: -18°C <p align="center">+</p> <p align="center">STORAGE CYCLE</p> <ul style="list-style-type: none"> ▶ Room temp setpoint: -20°C 	<p>HARD - Chapetr 9.2.8</p> <ul style="list-style-type: none"> ▶ Room temp setpoint: -40°C ▶ Core probe temp. setpoint: -18°C <p align="center">+</p> <p align="center">STORAGE CYCLE</p> <ul style="list-style-type: none"> ▶ Room temp. setpoint.: -20°C
--	---

TIME-BASED FREEZING

<p>SOFT - Chapetr 9.2.11</p> <p>60% of time Soft chilling</p> <ul style="list-style-type: none"> ▶ Room temp. setpoint.: 0°C <p>40% of time Hard chilling</p> <ul style="list-style-type: none"> ▶ Room temp. setpoint.: -40°C <p align="center">+</p> <p align="center">STORAGE CYCLE</p> <ul style="list-style-type: none"> ▶ Room temp. setpoint.: -20°C 	<p>HARD - Chapetr 9.2.10</p> <p>100% of time Hard chilling</p> <ul style="list-style-type: none"> ▶ Room temp. setpoint.: -40°C <p align="center">+</p> <p align="center">STORAGE CYCLE</p> <ul style="list-style-type: none"> ▶ Room temp. setpoint.: -20°C
--	--



 **9.2.4 POSITIVE SOFT CHILLING with core probe and subsequent storage**



The time-based chilling and storage cycle consists in two phases:

- ▶ **1st phase:** Soft chilling cycle (Room temp. setpoint 0°C; Core probe temp. setpoint 3°C)
- ▶ **2nd phase:** Storage (Room temp. setpoint 2°C)



- Make sure the blast chiller is in “ON/STAND-BY” mode, that the keyboard is not locked (chapter 11) and that no procedures are being carried out.

▶ Press and release the  key:	the  icon starts flashing
--	--

<p>The display shows the room’s temperature setpoint.</p> <p>▶ It is possible to use the   keys to modify this value.</p>

▶ Press and release the  key within 20 seconds:	<p> and  icons remain on, and a one-minute test is carried out, to make sure the core probe has been correctly inserted:</p> <ul style="list-style-type: none"> ▶ If the test has a positive outcome, the chilling cycle with core probe does not stop. ▶ If the test has a negative outcome (e.g. core probe not inserted), the acoustic buzzer warns us 3 times (each 10 seconds) that the core probe has not been inserted. In this case there is no need to press any keys, after 30 seconds a time-based cycle automatically begins.
--	--

During the chilling cycle a temperature, the display shows the temperature detected by the core probe, and the  icon is on.
--

<ul style="list-style-type: none"> ▶ It is possible to display the room’s temperature in any moment, pressing and releasing the  key. ▶ To restore the standard display mode, press and release the same key or do not operate for 15 seconds. ▶ Once the chilling cycle has been carried out, the blast chiller automatically switches to a storage cycle. ▶ During the storage, the display shows the temperature detected by the room probe and the  icon is on.

▶ To stop any cycle, press the  key.

NB: If the required temperature is not reached within the scheduled time (positive chilling: 90 min, freezing: 240 min), a recursive beep is issued as warning.

The blast chiller keeps chilling / freezing until reaching the scheduled temperature. Failure to reach the temperature within the scheduled time may take place when introducing products which are bigger in size or weight compared with the standard ones or products with higher temperature of the maximum allowed.



 9.2.5 POSITIVE HARD CHILLING WITH CORE PROBE and subsequent storage



The chilling cycle with core probe and subsequent storage consists in three phases:

- ▶ **1st phase: Hard chilling cycle** (Room temp. setpoint -20°C; Core probe temp. setpoint 15°C)
- ▶ **2nd phase: Soft chilling cycle** (Room temp. setpoint 0°C; Core probe temp. setpoint 3°C)
- ▶ **3rd phase: Storage** (Room temp. setpoint 2°C)



After completing a phase, the blast chiller automatically switches to the next one.



- Make sure the blast chiller is in “ON/STAND-BY” mode, that the keyboard is not locked (chapter 11) and that no procedures are being carried out.

▶ Press and release the  key	the  icon starts flashing.
---	---

▶ Press and release the  key	the HARD and  icon flash
---	--



The display shows the working setpoint during the chilling.

▶ It is possible to use the   keys to modify this value.

▶ Press and release the  key within 20 seconds	<p>the , HARD and  icon remain on, and a one-minute test is carried out, to make sure the core probe has been correctly inserted:</p> <ul style="list-style-type: none"> ▶ If the test has a positive outcome, the chilling cycle with core probe starts. ▶ If the test has a negative outcome (e.g. core probe not inserted), the acoustic buzzer warns us 3 times (each 10 seconds) that the core probe has not been inserted. In this case there is no need to press any keys, after 30 seconds automatically begins a time-based cycle.
---	--

During the chilling cycle, the display shows the temperature detected by the core probe, and the  icon is on.

- ▶ It is possible to display the room’s temperature in any moment, pressing and releasing the  key.
- ▶ To restore the standard display mode, press and release the same key or do not operate for 15 seconds.
- ▶ Once the chilling cycle has been carried out, the blast chiller automatically switches to a storage cycle.

▶ During the storage, the display shows the temperature detected by the room probe and the   icon is on.

▶ To stop the cycle, press the  key.

NB: If the required temperature is not reached within the scheduled time (positive chilling: 90 min, freezing: 240 min), the control board emits a repeated loud bleep as a warning.

The blast chiller keeps chilling / freezing until reaching the scheduled temperature. Failure of reaching the temperature within the scheduled time may take place when introducing products which are bigger in size or weight compared with the standard ones or products with higher temperature of the maximum allowed.



9.2.6 SOFT TIME-BASED CHILLING and subsequent storage

In order to select a time-based chilling cycle, you just need to make sure not to insert the core probe.



The Soft time-based and storage cycle consists in two phases:



- ▶ **1st phase: Soft chilling cycle** (Room temp. setpoint 0°C during the whole cycle)
- ▶ **2nd phase: Storage phase** (Room temp. setpoint 2°C)

- Make sure the core probe is not inserted.
- Make sure the blast chiller is in “ON/STAND-BY” mode, that the keyboard is not locked (chapter 11) and that no procedures are being carried out.

▶ Press and release the  key	the  icon starts flashing
---	--



The display shows the working setpoint during chilling.



▶ It is possible to use the   keys to modify this value and modify the values with the same keys

▶ Press and release the  key within 20 seconds:	The   icons remain on and the cycle starts
--	---

- ▶ The control board carries out a one-minute test, to make sure the core probe has been correctly inserted, the  icon flashes during the whole test, and turns off at the end of it.
- ▶ If the core probe has not been correctly inserted, the acoustic buzzer warns us 3 times (each 10 seconds).
- ▶ There is no need to press any keys, a time-based cycle will automatically begin.

During the chilling, the display shows the temperature detected by the room probe and the  and **min** icons remain on.

▶ It is possible to modify the duration of the cycle by pressing the   keys.

- ▶ To display the room’s temperature, press and release the . To restore the standard display mode, press and release the same key or do not operate for 15 seconds.
- ▶ Once the chilling has been completed, according to the scheduled duration, the blast chiller automatically switches to storage.
- During storage, the display shows the temperature detected by the probe, and the  icon is on.
- ▶ To stop the cycle, press the  key.

 **9.2.7 HARD TIME-BASED CHILLING and subsequent storage**









In order to select a time-based chilling cycle, you just need to make sure not to insert the core probe.





The Soft time-based and storage cycle consists in three phases:



- ▶ **1st phase: Hard chilling cycle** (60% of the whole duration of the cycle; Room temp. setpoint -20°C)
- ▶ **2nd phase: Soft chilling cycle** (40% of the whole duration of the cycle; Room temp. setpoint -0°C)
- ▶ **3rd phase: Storage cycle** (Room temp. setpoint: 2°C)

After completing a phase, the blast chiller automatically switches to the next one.

- Make sure the core probe is not inserted
- Make sure the blast chiller is in “ON/STAND-BY” mode, that the keyboard is not locked (chapter 11) and that no procedures are being carried out.

▶ Press and release the  key:	the  icon starts flashing
▶ Press and release the  key	the HARD icon starts flashing
<p>The display shows the working setpoint during the chilling. It is possible to use the   keys to modify this value</p>	
▶ Press and release the  key within 20 seconds:	The  , HARD and  icon remain on and the cycle starts
▶ The control board carries out a one-minute test, to make sure the core probe has been correctly inserted, the  icon flashes during the whole test, and turns off at the end of it.	

<p>If the core probe has not been correctly inserted, the acoustic buzzer warns us 3 times (each 10 seconds). There is no need to press any keys, a time-based cycle will automatically begin.</p> <ul style="list-style-type: none"> ▶ During the chilling, the display shows the time remaining before the end of the cycle. ▶ The  'icon turns off, while the  and min icons remain on. ▶ It is possible to modify the duration of the cycle by pressing the   keys.
<ul style="list-style-type: none"> ▶ To display the room's temperature, press and release the  key. ▶ To restore the standard display mode, press and release the same key or do not operate for 15 seconds.

- ▶ Once the Hard chilling has been completed, according to the scheduled duration, the blast chiller automatically switches to chilling SOFT.
- ▶ display shows the time remaining before the end of the chilling, the ,  and **min** remain on
- ▶ Once the chilling has been completed, according to the scheduled duration, the blast chiller automatically switches to storage.
- ▶ During storage, the display shows the temperature detected by the probe, and the  icon is on.





- ▶ To stop the cycle, press the  key.

9.2.8 HARD FREEZING WITH CORE PROBE and subsequent storage

The freezing time-based and storage cycle consists in two phases:





- ▶ **1st phase: Hard freezing cycle** (Room temp. setpoint -40°C; Core probe temp. setpoint -18°C)
- ▶ **2nd phase: Storage cycle** (Room temp. setpoint -20°C)

- Make sure the blast chiller is in “ON” mode, that the keyboard is not locked (chapter 11) and that no procedures are being carried out.

- | | |
|---|--|
| ▶ Press and release the  key | The  ,  ,  and HARD icons starts flashing |
|---|--|



The display shows the temperature setpoint during the chilling.

- ▶ It is possible to use the   keys to modify this value

- | | |
|--|--|
| ▶ Press and release the  key within 20 seconds: | The  ,  ,  , HARD and  icon remain on. |
|--|--|

- | | |
|---|--|
| A test is carried out, to make sure the core probe has been correctly inserted: | <ul style="list-style-type: none"> ▶ If the test has a positive outcome, the storing cycle with core probe is activated. ▶ If the test has a negative outcome, a time-based chilling cycle is activated. |
|---|--|

- ▶ During freezing, the display shows the temperature detected by the probe, and the  icon is on.

- ▶ To display the room's temperature, press and release the  key. To restore the standard display mode, press and release the same key or do not operate for 15 seconds.
- ▶ Once the freezing has been completed, the blast chiller automatically switches to storage.
- ▶ During storage, the display shows the temperature detected by the probe, and the  icon is on.
- ▶ To stop the cycle, press the  key.

NB: If the required temperature is not reached within the scheduled time (positive chilling: 90 min, freezing: 240 min), the control board emits a repeated loud bleep as a warning. The blast chiller keeps chilling / freezing until reaching the scheduled temperature.

Failure to reach the temperature within the scheduled time may take place when introducing products which are bigger in size or weight compared with the standard ones of the maximum allowed.



9.2.9 SOFT FREEZING WITH CORE PROBE and subsequent storage

The Sorf temperature-based freezing and storage cycle consists in three phases:

- ▶ **1st phase: Soft freezing cycle** (Room temp. setpoint 0°C; Core probe temp. setpoint +3°C)
- ▶ **2nd phase: Hard Freezing cycle** (Room temp. setpoint -40°C; Core probe temp. setpoint -18°C)
- ▶ **3rd phase: Storage cycle** (Room temp. setpoint -20°C)

After completing a phase, the blast chiller automatically switches to the next one.





- Make sure the blast chiller is in "ON" mode, that the keyboard is not locked (chapter 11) and that no procedures are being carried out.

▶ Press and release the  key	The  ,  and HARD icon starts flashing
---	---

▶ Press and release the  key	the HARD icon turns off
---	--------------------------------

The display shows the temperature setpoint during the freezing.

- ▶ It is possible to use the   keys to modify this value

▶ Once the values have been modified, press and release the  key	<p>The ,  and  icons remain on and a test is carried out to make sure the probe has been correctly inserted.</p> <ul style="list-style-type: none"> ▶ If the test has a positive outcome, the temperature-based freezing cycle is activated. ▶ If the test has a negative outcome, a time-based chilling cycle is activated.
---	--

▶ During the Soft freezing phase, the display shows the temperature detected by the probe, and the  icon is on.

▶ To display the room's temperature, press and release the  key. To restore the standard display mode, press and release the same key or do not operate for 15 seconds.

▶ Once the Soft freezing phase has been completed, the blast chiller automatically switches to freezing.

▶ During the freezing phase, the display shows the temperature detected by the probe, and the  icon is on.

Once the freezing phase has been completed, too, the blast chiller automatically switches to the storage phase.

▶ During the storage phase, the display shows the temperature detected by the probe, and the  icon is on.

▶ To stop the cycle, press the  key

NB: If the required temperature is not reached within the scheduled time (positive chilling: 90 min, freezing: 240 min), the control board emits a repeated loud bleep as a warning.

The blast chiller keeps chilling / freezing until reaching the scheduled temperature.

Failure to reach the temperature within the scheduled time may take place when introducing products which are bigger in size or weight compared with the standard ones of the maximum allowed.



9.2.10 HARD TIME-BASED FREEZING and subsequent storage

In order to select a HARD time-based freezing cycle, you just need to make sure not to insert the core probe

The time-based freezing and storage cycle consists in two phases:





- ▶ **1st phase: Hard Freezing cycle** (Room temp. setpoint -40°C during the whole cycle)
- ▶ **2nd phase: Storage cycle** (Room temp. setpoint -20°C)

- Make sure the core probe is not inserted.
- Make sure the blast chiller is in "ON" mode, that the keyboard is not locked (chapter 11) and that no procedures are being carried out.

▶ Press and release the  key: The ,  and **HARD** icons starts flashing



The display shows the working setpoint during the freezing.



▶ It is possible to use the   keys to modify this value.

<p>▶ Press and release the  key within 20 seconds:</p>	<p>The  ,  , HARD and  icon remain on and the cycle starts.</p>
---	--

▶ The control board carries out a one-minute test, to make sure the core probe has been correctly inserted. The  icon flashes during the whole test, and turns off at the end of it.

▶ If the core probe has not been correctly inserted, the acoustic buzzer warns us 3 times (each 10 seconds). There is no need to press any keys, a time-based cycle will automatically begin.

▶ During the freezing phase, the display shows the time left before the end of the freezing, and the  ,  ,  and min are on.

▶ It is possible to use the   keys to modify the duration of the cycle.

▶ To display the room's temperature, press and release the  key. To restore the standard display mode, press and release the same key or do not operate for 15 seconds.

▶ Once the freezing cycle has been completed, the blast chiller automatically switches to a storage cycle.

▶ During the storage phase, the display shows the temperature detected by the probe, and the  icon is on.

▶ To stop the cycle, press the  key

9.2.11 SOFT TIME-BASED FREEZING and subsequent storage



In order to select a SOFT time-based freezing cycle, you just need to make sure not to insert the core probe

The time-based freezing and storage cycle consists in three phases:

- ▶ **1st phase:** Soft freezing cycle (60% of the whole duration of the cycle; Room temp. setpoint 0°C)
- ▶ **2nd phase:** Hard Freezing cycle (40% of the whole duration of the cycle; Room temp. setpoint -40°C)
- ▶ **3rd phase: Storage** (Room temp. setpoint -20°C)



After completing a phase, the blast chiller automatically switches to the next one.





- Make sure the core probe is disabled.
- Make sure the blast chiller is in "ON" mode, that the keyboard is not locked (chapter 11) and that no procedures are being carried out.

<p>▶ Press and release the  key</p>	<p>The  ,  and HARD icon starts flashing</p>
--	--

<p>▶ Press and release the  key</p>	<p>The HARD icon turns off</p>
--	--------------------------------



The display shows the working setpoint during the freezing.



▶ It is possible to use the   keys to modify the duration of the cycle

▶ Press and release the  key within 20 seconds:	The  ,  and  icons remain on and the cycle starts
--	---

The control board carries out a one-minute test, to make sure the core probe has been correctly inserted. The  icon flashes during the whole test, and turns off at the end of it.



▶ If the core probe has not been correctly inserted, the acoustic buzzer warns us 3 times (each 10 seconds). There is no need to press any keys, a time-based cycle will automatically begin.

▶ During the Soft freezing phase, the display shows the time left before the end of the cycle, and the  ,  ,  and **min** are on.

▶ It is possible to use the   keys to modify the duration of the cycle

▶ To display the room's temperature, press and release the  key. To restore the standard display mode, press and release the same key or do not operate for 15 seconds.

▶ Once the first freezing phase has been completed, the blast chiller automatically moves to the second phase.

▶ During the freezing phase, the display shows the time left before the end of the cycle, and the  ,  ,  and **min** icons are on.

▶ Once the freezing phase has been completed, the blast chiller automatically moves to the storage phase.

▶ During the storage phase, the display shows the temperature detected by the core probe, and the  icon is on.



▶ To stop the cycle, press the  key.

9.2.12 Activation of a PRECOOLING CYCLE

Each cooling/freezing cycle might be preceded by precooling to blast chiller

Precooling temperature is set by default at 0° C and cannot be modified by the user.

- Make sure the blast chiller is in "ON" mode, that the keyboard is not locked (chapter 11) and that no procedures are being carried out.



▶ Press the  key for 1 second	the  icon starts flashing
--	--

▶ To stop the precooling:	press the  key for 1 second or start a working cycle
---------------------------	--

9.2.13 Activation of a MANUAL DEFROSTING cycle

Defrosting is activated manually, and lasts no longer than 30 minutes.
The cycle ends when the evaporator probe detects a temperature of 8°C.

- Make sure the blast chiller is in “ON” mode, that the keyboard is not locked (chapter 11) and that no procedures are being carried out.
- Air defrosting is carried out: the chiller’s door must therefore be left open during the whole duration of the cycle.

▶ Press the  key for 4 seconds to start the defrosting	The display shows the  icon.
---	---

NB: It is advisable to perform a defrosting cycle daily, if possible at the end of the working day

CHAPTER 10 ALARMS



ALLARM	DESCRIPTION	CAUSE	SOLUTION
Pr1	Room probe error (all cycles are blocked)	▶ Room probe failure	▶ Replace probe
Pr2	Core probe error (you can not run cycles to core probe)	▶ Core probe failure	▶ Replace probe
Pr3	Evaporator probe error	▶ Evaporator probe failure	▶ Replace probe
HP Only for ABF 05 E/C models	High pressure alarm (all cycles are blocked)	▶ Dirty condenser ▶ This product was added too hot	▶ Condenser cleaning ▶ Cool Down product
AL	Minimum temperature alarm	▶ Cell probe fails ▶ Unit fails	▶ Service ▶ Service
AH	Maximum temperature alarm	▶ Cell probe fails ▶ Unit fails ▶ Refrigeration system failure	▶ Service ▶ Service ▶ Service
PF	Interruption of electrical power	▶ Electrical power failure occurred	▶ Press any key to clear the alarm
TIME + Acoustic bleep Acoustic bleep	The chilling / freezing cycles with core probe have not been carried out within the scheduled time	▶ This product was added too hot ▶ Refrigeration system failure	▶ Repeat cycle ▶ Service
Loc	keyboard locked	▶ The keyboard is locked	▶ See cap. 11
UnL	keyboard unlocked	▶ The keyboard is unlocked	▶ See cap. 11

CAPITOLO 11 KEYBOARD LOCK



11.1 Lock / unlock keyboard

- Make sure the keyboard is not locked and that no procedures are being carried out

Lock keyboard

▶ Press simultaneously the  and  keys until the label is displayed.	“Loc”
---	--------------

Unlock keyboard

▶ Press simultaneously the  and  keys until the label is displayed.	“UnL”
---	--------------

The blast chiller is designed and constructed so that risks resulting from the emission of airborne noise are reduced to the minimum level (see technical information).

CHAPTER 13 MATERIALS AND FLUIDS USED

ABF 04 -05 - 07 -10 - 15: The materials in contact or which may come into contact with foodstuffs comply with the relevant directives. The blast chiller has been designed and built in such a way that these materials can be cleaned before each use. The refrigerant fluids used R452A conform with the new EU regulation 517/2014 F-Gas R452A is a fluorinated gas, it has a GWP potential of 2141

ABF TRAY MINI: We hereby inform our clients that this product employs an HC (Hydrocarbon) refrigerating gas classified as A2, i.e. flammable. Devices with flammable refrigerating gases are identified with the following label on the device:



R290

IMPORTANT SAFETY INSTRUCTIONS AND CAUTIONS: Although the gas quantity contained in the device complies with the norms on the subject, more precautions in the management of the device are requested, most of all when works on the refrigerating system have to be carried out:

- The refrigerating circuit must not be damaged to avoid leaks, because the contact between air and gas entails the risk of fires in case of presence of a suitable primer, such as open flame or sparks coming from electrical appliances. If any replacement of components is necessary, demand only original and homologated parts for specific use.
- In case of technical works due to malfunctions, please only contact qualified personnel who can carry them out according to the compulsory safety norms for this kind of gas. The tools used for working on the device must comply to the same rules concerning the refrigerating system components: no electrical appliances nor flames must be used in the presence of flammable gases.
- Specific works regarding vacuum and system charge will have to be carried out with the suitable tools for the type of gas, avoiding the presence of flammables and the contact with flames or sparks.

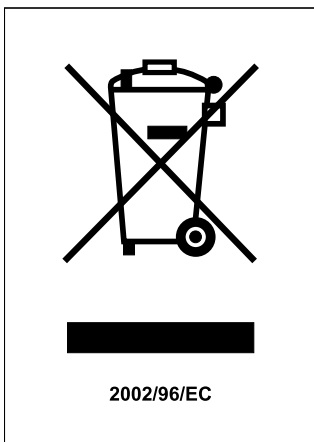

The symbol indicates that this product must not be treated as household waste.

To prevent potential negative consequences for the environment and human health, make sure that this product is properly disposed of and recycled.

For more information regarding the disposal and recycling of this product, please contact your Distributor, after sale Service, or waste treatment Service.

CHAPTER 14 TRANSPORT AND HANDLING



The transport and handling of the blast chiller must only be done while maintaining the vertical position, observing the markings on the packaging.

The manufacturer disclaims any liability for problems resulting from transport performed under conditions other than those specified above.

The accessories of the blast chiller (guides, grilles, trays) are packaged separately and placed inside the blast chiller.

The blast chiller is mounted on a wooden base and protected from accidental impact with polyethylene, carton, crate or boxes.

Regarding the disposal of the packaging it is necessary to refer to current regulations in your country.



The movement of the blast chiller shall be performed using a fork lift or pallet trucks equipped with suitable forks (length of at least 2/3 of the blast chiller).

The dimensions and masses of the refrigerated cabinets packed are shown in Table 1.

The limits of stackability and the centre of gravity are indicated on the label of the package.

14.1 Positioning operations

Since the incorrect positioning of the blast chiller can cause damage to the same, jeopardizing its proper functioning and result in risk to the personnel, the installer must adhere to the following general rules:

- position the blast chiller keeping minimum 3 cm distance from any wall and 50 cm from ceiling
- the environment must be sufficiently ventilated
- position the blast chiller away from heat sources
- avoid exposure to direct sunlight
- remove the polyethylene, cardboard or wood packaging



Polyethylene is dangerous for children

- remove any accessories with external connections

Removing the wooden base (Fig.4): lift the blast chiller and remove the base.

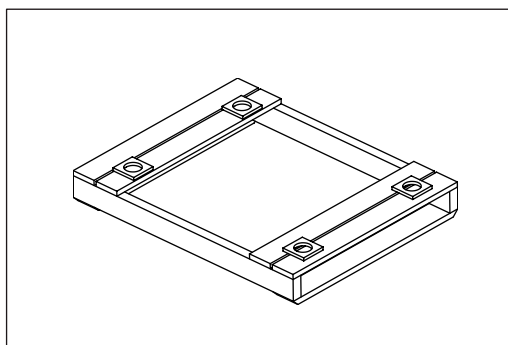

Fig.4



use protective gloves when handling the wooden packaging and the wooden base.

The presence of splinters may cause damage to your hands

- remove the PVC film applied as a protection to the outer surfaces of the blast chiller
- position the blast chiller using a level with possible adjustment of the feet of the metal base (Fig. 5)

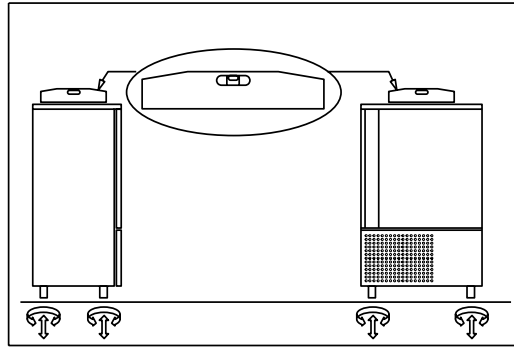

Fig.5

- position the grille holding guide rails in the holes of the racks (Fig. 6)

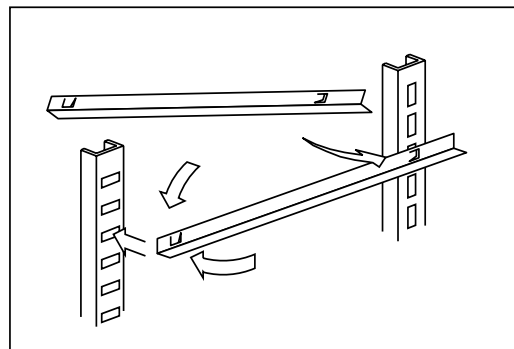

Fig.6

- insert the grilles for food in the special guides
- insert the condensate water drain pan into the special guide rails already fixed under the blast chiller if provided.

14.2 REM Blast chillers (Fig. 7)

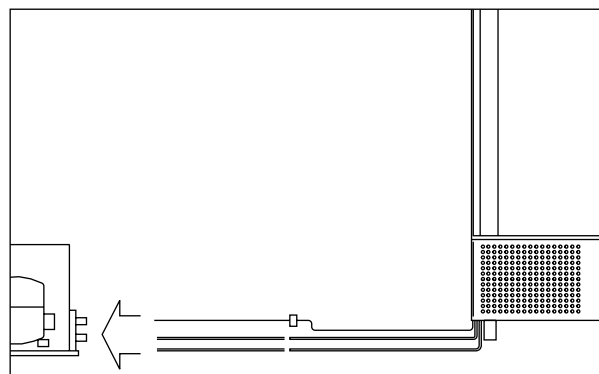

Fig.7

- position the blast chiller as described above (Fig. 5)
- N.B.: the system is pressurized by the manufacturer with Azoto
- prepare the two pipes that protrude from the temperature blast chiller for the connection to the respective pipes

- connect the pipes of the condensing unit to the pipes of the blast chiller
- create a vacuum and then carry out the loading of the refrigerant
- make the electrical connection of the blast chiller to the condensing unit

CHAPTER 15 ELECTRICAL WIRING AND CONNECTIONS

The electrical system and connection must be carried out by qualified personnel. Before installation, measure the impedance of the network, the impedance value for the connection to the network must not exceed 0.075 ohm.

For safety reasons you must follow these guidelines:

- verify that the sizing of the electrical system is suitable for the power consumption of the blast chiller and that it provides for a differential switch (circuit breaker)
- in case of incompatibility between the outlet and the plug of the blast chiller, replace the outlet with another of a suitable type provided that it is in accordance with regulations
- do not insert adapters and/or reductions (Fig. 8)

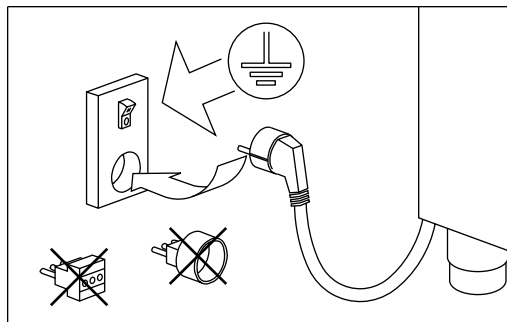



Fig.8

 The power cord has the connection type “Y” and it can be replaced exclusively by the manufacturer or authorized technical service

 It is essential to correctly connect the blast chiller to an efficient earthing system carried out as specified by the applicable provisions of law.

CHAPTER 16 INSTALLATION OPERATIONS

It is important, in order to prevent errors and accidents, to perform a series of checks before starting up the blast chiller in order to identify any damage incurred during transport, handling and connection.

Checks to be performed:

- check the integrity of the power cord (it must not have suffered abrasions or cuts)
- check the solidity of the legs, door hinges, shelf supports
- check the integrity of the internal and external parts (pipes, heating elements, fans, electrical components, etc.) and their fixing
- check that the seals of the doors and drawers have not been damaged (cuts or abrasions) and close with an airtight seal
- check the integrity of the pipes and fittings

CHAPTER 17 REINSTALLATION

It is necessary to comply with the following procedure:

- disconnect the power cord from the power outlet
- the handling should be carried out as described in chapter 14
- for a new placement and connection, please refer to par. 14.1
- proceed to the possible recovery of the refrigerant gas in accordance with the regulations in force in your country



WARNING!

**INSTRUCTIONS STRICTLY RESERVED TO AUTHORIZED
TECHNICAL PERSONNEL**

Every intervention executed by a non authorized technical personnel
implies a warranty decay.

Display and modify parameters

BUTTONS	DISPLAY
Press the UP and DOWN buttons at the same time for 4 seconds	PA
Press CHILLING	0
Press the DOWN button and set the Password -19	
Press CHILLING	PA
Press again the UP and DOWN buttons at the same time for 4 seconds	SP (first parameter)
Scroll the parameters with the UP button	Parameter required
Press CHILLING to display the value	
Edit the parameter using the UP and DOWN buttons	Modified value
Press CHILLING to confirm the new value	
Exit from the program setting pressign both the UP and DOWN buttons or do not operate for 60 seconds	

CONFIGURATION PARAMETERS ABF MINI /03/05 E-C

NB only the highlighted parameters can be modified by maintenance service. The other parameters can be modified only after reference/authorization by our technical department.

Par.	Min.	Max.	Unit	Default	Analogue inputs
CA1	-25.0	25.0	°C °F (1)	0.0	cabinet probe offset
CA2	-25.0	25.0	°C °F (1)	0.0	needle probe offset
CA3	-25.0	25.0	°C °F (1)	0.0	evaporator probe offset
CA4	-25.0	25.0	°C °F (1)	0.0	condenser probe offset
PO	0	1	- - - -	1	probe type 0 = PTC 1 = NTC
P1	0	1	- - - -	1	°C decimal point °C 1 = si
P2	0	1	- - - -	0	temperature unit of measurement (2) 0 °C 1 °F
P3	0	1	- - - -	1	enabling the needle probe 1 = si
P4	0	1	- - - -	1	enabling the evaporator probe 1 = si
P5	0	1	- - - -	0	fourth input function 0 = high pressure input (digital input) 1 = condenser probe (analogue input)
P8	0	250	ds	5	delay displaying temperature variation detected by the probes

Par.	Min.	Max.	Unit	Default	Main regulator
r0	0.1	15.0	°C / °F (1)	2.0	parameters differential r7, r8, r9, r10, r11 e r12
r1	1	500	min	90	duration of time-controlled blast chilling
r2	1	500	min	240	duration of time-controlled deep freezing
r3	-99.0	99.0	°C / °F (1)	3.0	temperature-controlled blast chilling end time temperature; also end temperature of the temperature-controlled soft deep freezing phase (temperature detected by the needle probe); also see parameter r5
r4	-99.0	99.0	°C / °F (1)	-18.0	temperature-controlled deep freezing end temperature (temperature detected by the needle probe); also see parameter r6
r5	1	500	min	90	maximum duration of temperature-controlled blast chilling; also see parameter r3
r6	1	500	min	240	maximum duration of temperature-controlled deep freezing; see parameter r4 also
r7	-99.0	99.0	°C °F (1)	0.0	work set-point during blast chilling; also work set-point during the soft deep freezing phase (cabinet temperature); also see parameter r0
r8	-99.0	99.0	°C °F (1)	-40.0	work set-point during deep freezing (cabinet temperature); also see parameter r0

ENGLISH

r9	-99.0	99.0	°C °F (1)	-20.0	work set-point during blast chilling hard phase (cabinet temperature); also see parameter r0
r10	-99.0	99.0	°C °F (1)	2.0	work set-point during post blast chilling storage (cabinet temperature); also see parameter r0
r11	-99.0	99.0	°C °F (1)	-20.0	work set-point during post deep freezing storage (cabinet temperature); also see parameter r0
r12	-99.0	99.0	°C °F (1)	0.0	work set-point during pre-cooling (cabinet temperature); also see parameter r0
r13	-99.0	99.0	°C °F (1)	15.0	end temperature of the temperature-controlled hard blast chilling phase (temperature detected by the needle probe)
r14	10	100	%	60	duration of the time-controlled hard blast chilling phase (intended as a percentage of the value established with parameter r1); also duration of the time-controlled soft deep freezing phase (intended as a percentage of the value established with parameter r2)
r15	-99.0	99.0	-C °F (1)	65.0	temperature below which the count of the maximum temperature-controlled blast chilling and maximum temperature-controlled deep freezing is started (temperature detected by the needle probe)
r16	0	2	- - - -	1	type of operating cycle that can be selected 0 = blast chilling and storage 1 = blast chilling and storage or deep freezing and storage 2 = deep freezing and storage
r17	0.0	99.0	-C °F (1)	5.0	"temperature detected by the needle probe - cabinet temperature" minimum difference such to consider the first phase of the test to verify correct insertion of the needle probe completed successfully (consider the difference without sign) 0.0 = the test will not be performed (neither first or second phase)
r18	1	99	s	1	duration of the second phase of the test for verification of correct insertion of the needle probe
r19	0	1	- - - -	0	quick modification value during the "On" status before starting the operating cycle 0 = work set-point during blast chilling or during deep freezing 1 = blast chilling or deep freezing end temperature
r20	0	1	- - - -	1	memorisation of the quick modification value during the "On" status before starting the operating cycle 0 = no (on start-up of the successive same cycle, the values established with parameters r7 and r3 or those establishes with r4 and r8 will be re-proposed) 1 = yes (on start-up of the successive same cycle the rapidly modified values will be re-proposed before starting the previous same cycle)
r21	0	1	- - - -	0	modality the operating cycle is started time controller rather than time controlled 0 = automatic (or through the test regarding correct insertion of the needle probe) 1 = by hand (or pressing and releasing the BLAST CHILLING or DEEP FREEZING key)
r22	0	1	- - - -	0	modality to start pre-cooling 0 = automatic (or pressing the BLAST CHILLING key 1 s) 1 = both automatic (or passing from the "stand-by" status to the "on", then switching on the device) and by hand (or pressing the BLAST CHILLING key 1 s)
r23	0	50	S	2	duration of the buzzer activation to signal the verification test for the correct insertion of the needle probe will not have been completed successfully
Par.	Min.	Max.	Unit	Default	Compressor protections
CO	0	240	min	0	minimum time between restoring the power supply after a power cut, occurring during an operating cycle and compressor switch-on
C1	0	240	min	5	minimum time between two consecutive compressor switch-ons (3)
C2	0	240	min	3	minimum time between compressor switch-off and successive switch-on (3)
C3	0	240	s	0	compressor switch-on minimum duration
C4	0	240	min	10	duration of compressor switch-off during the cabinet probe error ("Pr1" code) that occurs during storage; see also parameter C5
C5	0	240	min	10	duration of compressor switch-on during the cabinet probe error ("Pr1" code) that occurs during post blast chilling storage; also see parameter C4
C6	0	199.0	°C °F (1)	80.0	condenser temperature above which the blocked overheated condenser alarm is activated ("COH" code)
C7	0	199.0	°C °F (1)	90.0	condenser temperature above which the blocked compressor alarm is activated ("CSd" code)
C8	0	15	min	1	blocked compressor alarm delay ("CSd" code) (5)
C9	0	240	min	30	duration of compressor switch-on during the cabinet probe error ("Pr1" code) that occurs during post deep freezing storage; also see parameter C4
Par.	Min.	Max.	Unit	Default	Defrosting (6)
dO	0	99	h	0	defrosting interval (7) 0 = defrosting will never be activated at intervals

ENGLISH

d1	0	3	----	2	type of defrosting 0 = electrical (the compressor will be switched off during defrosting, the defrosting output will be activated and the evaporator fan will be switched off) 1 = hot gas (the compressor will be switched on during defrosting, the defrosting output will be activated and the evaporator fan will be switched off) 2 = air (the compressor will be switched off during defrosting and the defrosting output will be activated; the evaporator fan will be switched on, independently from the conditions of the door, i.e. independently from the door micro switch input status) 3 = air with door open (the compressor will be switched off during defrosting and the defrosting output will be activated; the evaporator fan will be switched on, on condition that the door is open, i.e. that is on condition that the door micro switch is active and that the parameter i0 is set at values different to 0)
d2	-99.0	99.0	-C °F (1)	8.0	defrosting end temperature (evaporator temperature); also see parameter d3
d3	0	99	min	30	if parameter P4 is set at 0, duration of defrosting if parameter P4 is set at 1, maximum duration of defrosting; see also parameter d2 0 = defrosting will never be activated
d4	0	1	----	0	defrosting on start-up of blast chilling and deep freezing 1 = yes
d5	0	99	min	0	defrosting delay on start-up of storing 0 = defrosting will be started on expiry of the time established with parameter d0
d7	0	15	min	2	dripping duration (the compressor and the evaporator fan remain off during dripping and the defrosting output will be deactivated)
d15	0	99	min	0	minimum duration of compressor switch-on on activation of defrosting so these can be activated (only if parameter d1 is set at 1) (8)
d16	0	99	min	0	duration of pre-dripping (only if parameter d1 is set at 1; the compressor and evaporator fan will be off during pre-dripping and the defrosting output will remain activated)
Par.	Min.	Max.	Unit	Default	Temperature alarms (9) (10)
A1	0.0	99.0	°C / °F (1)	10.0	cabinet temperature below which the minimum temperature alarm is activated (relative to the work set-point, i.e. "r10 - A1" during post blast chilling storage and "r11 - A1" during post deep freezing storage; ("AL" code); also see parameter A11 (4)
A2	0	1	----	0	enabling of minimum temperature alarm ("AL" code) 1 = yes
A4	0.0	99.0	-C / °F (1)	10.0	cabinet temperature above which the maximum temperature alarm is activated (relative to the work set-point, i.e. "r10 +A4" during post blast chilling storage and "r11 +A4" during post deep freezing storage; ("AH" code); also see parameter A11 (4)
A5	0	1	----	1	enabling of maximum temperature alarm ("AH" code) 1 = yes
A7	0	240	min	15	temperature alarm delay ("AL" code and "AH" code)
A8	0	240	min	15	maximum temperature alarm delay ("AH" code) from the conclusion of evaporator fan stop and storage start-up
AA	0	240	s	5	duration of buzzer activation on conclusion of blast chilling and deep freezing
All	0,1	15,0	-C °F (1)	2,0	parameters A1 and A4 differential
Par.	Min.	Max.	Unit	Default	Evaporator and condenser fan
FO	0	2	----	1	evaporator fan activity during pre-cooling, blast chilling and deep freezing 0 = off 1 = on; see also parameters F16 and F17 2 = parallel to the compressor; also see parameters F9 and F17
F1	-99.0	99.0	°C °F (1)	10	evaporator temperature above which the evaporator fan is off during storage (only if parameter F2 is set at 3); also see parameter F8 (11)
F2	0	3	----	2	evaporator fan activity during storage 0 = off 1 = on 2 = parallel to the compressor; also see parameter F9 3 = on; also see parameter F1
F3	0	15	min	2	duration of evaporator fan standstill (the compressor can be on during evaporator fan standstill, the defrosting output will remain deactivated and the evaporator fan will remain off)
F8	0.1	15.0	°C / °F (1)	2.0	F1, F16 and F17 parameters differential
F9	0	240	s	30	evaporator fan switch-off delay from compressor switch off (only if parameter F0 and/or parameter F2 are set at 2)
F15	0	240	s	15	evaporator fan delay from door closure, i.e. from the deactivation of the door micro switch input
F16	-99.0	99.0	-C °F (1)	70.0	evaporator temperature above which the evaporator fan is off during pre-cooling, blast chilling and deep freezing (only if parameter F0 is set at 1); also see parameter F8 (11)
F17	-99.0	99.0	-C °F (1)	90.0	cabinet temperature above which the evaporator fan is off during pre-cooling, blast chilling and deep freezing (only if parameter F0 is set at 1 or 2); also see parameter F8
Par.	Min.	Max.	Unit	Default	Digital input

ENGLISH

i0	0	2	----	2	effect caused by opening the door, i.e. by activation of the door micro switch (14) 0 = no effect 1 = the compressor and the evaporator fan will be off and the cabinet light will be on. On expiry of the time established with parameter i2, the display will show the flashing "id" code and the buzzer will be activated (until the door is closed); also see parameter F15 (15) 2 = the evaporator fan will be off and the cabinet light will be on. On expiry of the time established with parameter i2, the display will show the flashing "id" code and the buzzer will be activated (until the door is closed); also see parameter F15
i1	0	1	----	0	type of door micro switch input contact 0 = normally open (input active with closed contact) 1 = normally closed (input active with open contact)
i2	-1	120	min	5	door open alarm signalling delay ("id" code); on expiry of the time established with the parameter, the compressor will be off -1 = the alarm will not be signalled
i5	0	1	----	1	effect caused by the activation of the high pressure input 0 = no effect 1 = the compressor and the evaporator fan will be off and the condenser fan will be on. On expiry of the time established with parameter i7, the display will show the flashing "HP" code and the buzzer will be activated (until the input is deactivated)
i6	0	1	----	1	type of high pressure input 1 0 = normally open (input active with closed contact) 1 = normally closed (input active with open contact)
i7	-1	240	s	5	high pressure alarm signalling delay ("HP" code) -1 = the alarm will not be signalled
Par.	Min.	Max.	Unit	Default	Digital outputs
u0	0	1	----	1	utility managed by the output K2 (16) 0 = defrosting (in this case, the "d" parameters will assume significance) 1 = evaporator fan (in this case, the "F" parameters will assume significance)
Par.	Min.	Max.	Unit	Default	Serial communication (MODBUS)
LA	1	247	----	247	device address
Lb	0	3	----	2	baud rate 0 = 2.400 baud 1 = 4.800 baud 2 = 9.600 baud 3 = 19.200 baud
LP	0	2	----	2	Parity 0 = none (nessuna parità) 1 = odd (dispari) 2 = even (pari)

ALLARMS







Each alarm is characterized by a buzzer sound. Turn off the buzzer with the DOWN button . To view the list of alarms, see section 10.

TEMPERATURE DISPLAY AND OPERATING HOURS COMPRESSOR

While the blast chiller is in "ON" mode, the display shows a series of data.







DISPLAYING DETECTED BY CELL PROBE

- Make sure the keyboard is not locked (chapter 11) and that no procedures are being carried out.

▶ Press the  key for 3 seconds	
▶ Select the first label available ("Pb 1") using the   keys	
▶ Press and release the  key	the display shows the room's temperature
▶ To go back to menu press the  , key, to exit press the  key or do not operate for 15 seconds.	







DISPLAYING DETECTED BY CORE PROBE

- Make sure the keyboard is not locked (chapter 11) and that no procedures are being carried out

▶ Press the  key for 3 seconds	
▶ Select "Pb 2" label with the   keys	
▶ Press and release the  key	the display shows the temperature detected by the core probe.
▶ To go back to menu press the  , key, to exit press the  key or do not operate for 15 seconds.	







DISPLAYING DETECTED BY EVAPORATOR PROBE

- Make sure the keyboard is not locked (chapter 11) and that no procedures are being carried out

▶ Press the  key for 3 seconds	
▶ Select "Pb 3" label with the   keys	
▶ Press and release the  key	the display shows the temperature detected by the evaporator probe.
▶ To go back to menu press the  , key, to exit press the  key or do not operate for 15 seconds.	









VIEWING THE HOURS OF OPERATION COMPRESSOR

- Make sure the keyboard is not locked (chapter 11) and that no procedures are being carried out

▶ Press the  key for 3 seconds	
▶ Select "CH" label with the   keys	
▶ Press and release the  key	the display shows the total hours of operation compressor
▶ To go back to menu press the  , key, to exit press the  key or do not operate for 15 seconds.	

RESET THE HOURS OF OPERATION COMPRESSOR

- Make sure the keyboard is not locked (chapter 11) and that no procedures are being carried out

▶ Press the  key for 3 seconds	
▶ Select "rCH" label with the   keys	
▶ Press and release the  key	the display shows "0"
▶ Press the  key and set 149	the display shows "149"
▶ Press and release the  key	the display shows "----" and the hours of the compressor will be reset.
▶ To go back to menu press the  , key, to exit press the  key or do not operate for 15 seconds.	

BASIC TRAY MINI - 04 - 05 - 07 - 10

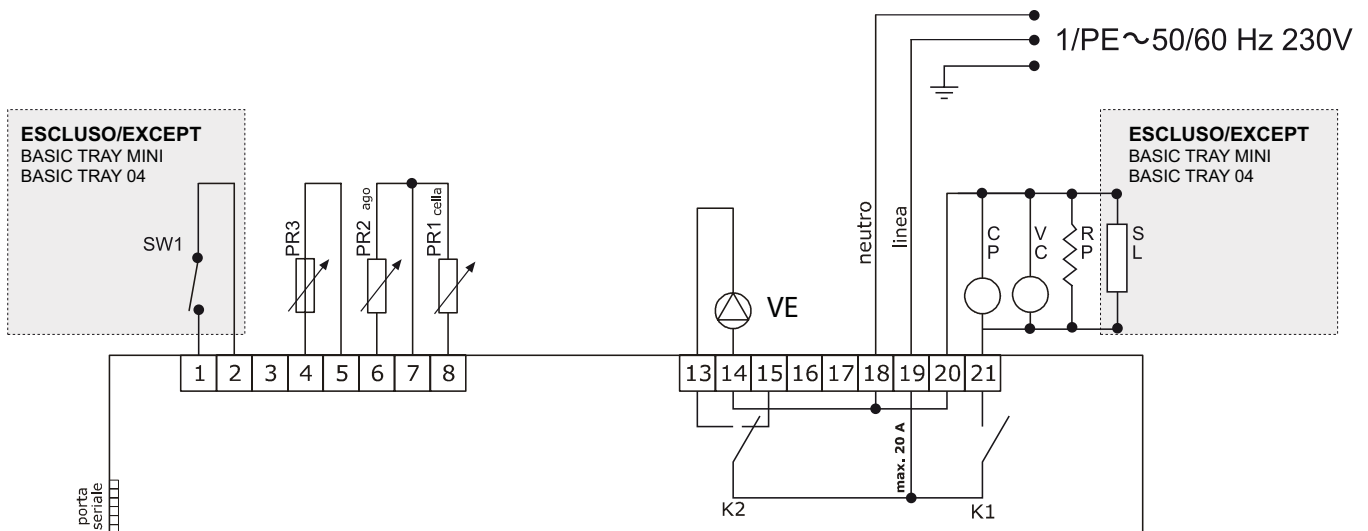

BASIC TRAY 15

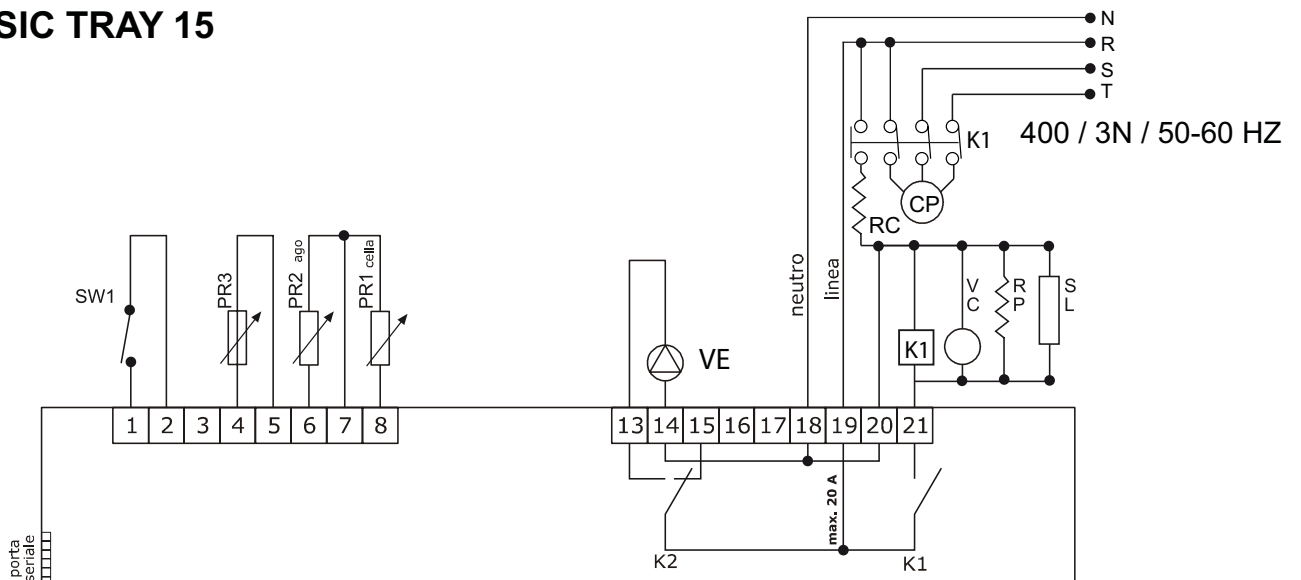

Components key:

- CP - Compressor
- K1 - Compressor relay
- RP - Anti-condensate heater
- VC - Condenser fan
- SL - Liquid solenoid valve

- VE - Evaporator fan
- PR1 - Cell probe
- PR2 - Needle probe
- PR3 - Evaporator probe
- SW1 - Pressostat
- RC - Carter resistance